

assfalg
TOOLS

● HAND-HELD MACHINES

● TV 95-SL

● STATIONARY MACHINES

assfalg
MACHINES

assfalg
MAGNETS

● MOBILE & STATIONARY
MACHINES

Deburring | Chamfering

Handheld, mobile and stationary machines

Assfalg chamfering and deburring machines
for chamfering, deburring, rounding edges,
and preparing weld seams



The Ace for Metal

MAGNETS MACHINES TOOLS

Assfalg GmbH

Buchstraße 149
73525 Schwäbisch Gmünd
Germany

Phone +49 (0) 71 71 92 505-0

Fax +49 (0) 71 71 92 505-50

info@assfalg-metal.com

www.assfalg-metal.com

The right of changes and deviating pictures is reserved. Liability is excluded.

Design and production:
Hela Werbung GmbH | www.hela.com

Assfalg machines in application



Deburring | Chamfering

Handheld, mobile and stationary machines



Handheld machines



 <p>Straight edges</p>	 <p>Contours</p>	<p>Mango II Universal Hand Tool A GLO-BURR 07</p> <p>Hand Deburrer</p>	 <p>Straight edges</p>	 <p>Contours</p>	<p>SMA 20-EF24 SMA 20-PF25 14</p> <p>Chamfering Machine, handheld, electric pneumatic</p>
 <p>Straight edges</p>	 <p>Contours</p>	<p>DHB 330 DHB 520 08</p> <p>Pneumatic Hand Belt Grinder</p>	 <p>Straight edges</p>	 <p>Contours</p>	<p>SMA 30-EVR24 SMA 30-PV25 15</p> <p>Chamfering Machine, handheld, electric pneumatic</p>
 <p>Straight edges</p>	 <p>Contours</p>	<p>AG 360 AG 460 GDS 009 101-E 09</p> <p>Pneumatic Grinder</p>	 <p>Straight edges</p>	 <p>Contours</p>	<p>SMA 40-E SMA 50-E SMA 40-P 16</p> <p>Chamfering Machine, handheld, electric pneumatic</p>
 <p>Straight edges</p>	 <p>Contours</p>	<p>MTQ 100 MH F3 F6 S3 MT W 10</p> <p>Electric Grinder</p>	 <p>Straight edges</p>	 <p>Contours</p>	<p>SMA 60-EVS 17</p> <p>Chamfering Machine, handheld, electric</p>
 <p>Straight edges</p>	 <p>Contours</p>	<p>ASO 300 ASO 310 12</p> <p>Chamfering Machine, handheld, pneumatic</p>	 <p>Straight edges</p>		<p>ASO 750 ASO 760-2 18</p> <p>Chamfering Machine, deburring machine, handheld, electric</p>
 <p>Straight edges</p>		<p>ASO 313 ASO 312 13</p> <p>Chamfering Machine, handheld, electric pneumatic</p>	 <p>Straight edges</p>		<p>ASO 760-3 19</p> <p>Chamfering Machine, Deburring Machine, handheld, electric</p>

Mobile and stationary machines



Straight edges

KBM 18

20

Chamfering Machine,
selfpropelling



Straight edges

Quicker | Maxiquicker 21

21

Chamfering Machine,
selfpropelling



Straight edges

ASO 900 | ASO 900 Plus | ASO 900 Plus-Bigger

22

Chamfering Machine,
selfpropelling



Straight edges

ASO 930 | ASO 930 Plus

23

Chamfering Machine,
selfpropelling



Straight edges

ASO 910

24

Chamfering Machine,
selfpropelling



Straight edges

ASO 920

25

Chamfering Machine,
selfpropelling

Deburring | Chamfering

Handheld, mobile and stationary machines



Stationary machines



BKE 550 26
Sheet Deburring Machine



ASO 650 | ASO 650-WSL 32
Chamfering Machine with V-prism for Straight Edges



AF 165 27
Beveling Machine with Sanding Disk



ASO 160-S | ASO 160-SSL 34
Chamfering Machine with V-prism for Straight Edges



KSM 125 | KSM 130 28
Chamfer Grinding Machine for Straight Edges



ASO 160-M | ASO 160-MSL 36
Chamfering Machine with V-prism for Straight Edges



Speedy Prisma 210-P | 210-PSL 29
Beveling Machine with Sliding Carriage



WKF 170 38
Chamfering Machine, angle adjustable



FS 5 30
Beveling Machine with V-prism



MMB 400 | MMB 500 | MMB 600 40
Chamfering Machine, angle adjustable



ASO 850-K 31
Beveling Machine with V-prism for Straight Edges

Stationary machines



Straight edges



Contours

Speedy Kontur 42
270-K | 270-KSL |
320-E | 320-KSL
Beveling Machine for Contours



Straight edges



Contours

TV 95-SL 52
Tub Vibrator |
Stone Vibration Deburring and
Slide Grinding Machine



Straight edges



Contours

KKE 1 | KKE 2 44
Beveling Machine for Contours



Straight edges



Contours

TV 15-SL | 40-SL | 54
100-SL | 200-SL
Tub Vibrator |
Stone Vibration Deburring and
Slide Grinding Machine



Straight edges



Contours

ASO 600-A | 46
ASO 600-ASL
Beveling Machine for Contours



Straight edges



Contours

ASM 18 | ASM 60 55
Centrifugal Grinding Machine



Straight edges



Contours

KKF 4 | KKF 4-SL 48
Chamfering Machine
for Contours



Straight edges



Contours

RV 40-SL | 120-SL | 56
220-SL | 420-SL
Rotary Vibrator |
Stone Vibration Deburring and
Slide Grinding Machine



Straight edges



Contours

KKF 3 50
Chamfering Machine
for Contours



Straight edges



Contours

RT 200 | RT 400 | 57
RT 600 | RT 800
Rotary Dryer |
for the Rotary Vibrator

MZ 35 | MZ 90 58
Centrifuge

Deburring | Chamfering

Handheld, mobile and stationary machines



Stationary machines



Straight edges



Contours

UA 5

Power Engine

59

EDG 213 | EDG 1226

Drill Grinder

60

NEUTRIX

Electrode Grinding Machine

61

Mango II | Universal Hand Tool A | GLO-BURR

Hand Deburrer

The high quality hand deburrers are a favourite and wanted compact tool for the daily manual use. You can deburr drills, slots and edges. Varied blades for different works are available. Rotatable blades adapt to the contour of the workpiece.



GLO-BURR



Universal Hand Tool A

Handheld



Straight edges



Contours



Further accessories can be found in our **Accessory Catalogue**.

Application

- ▶ Chamfering of workpieces made of steel, stainless steel, aluminium, brass and plastic materials
- ▶ Chamfering of straight edges and contours



Features

- ✔ Easy and handy form
- ✔ Simple handling
- ✔ Coated and uncoated blades

Options

- ✔ Different handles
- ✔ Different blade holders
- ✔ Different blades

Delivery contents

- ✔ Available individually or in a set

Technical data

	Mango II	Universal Hand Tool A	GLO-BURR
Blade holder	B, C, E	B, C, E	-
Blade	B, C, E	B, C, E	E
Max. chamfer width	1 mm	1 mm	1 mm
Weight	0.08 kg	0.08 kg	0.02 kg
No.	61111	63	63258

DHB 330 | DHB 520

Pneumatic Hand Belt Grinder

The pneumatic hand belt grinder machines are used for the surface-, contour- and shape cut. The grinder is very flexible, because of the 360° adjustable grinding arm. The sanding belt is easily and quickly exchanged.



DHB 330

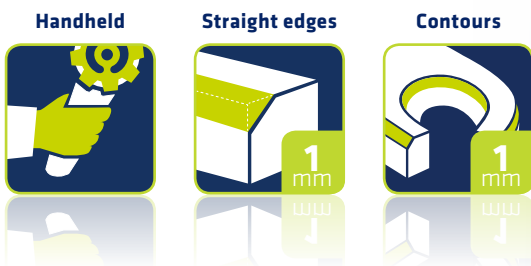

Further accessories can be found in our **Accessory Catalogue**.

Application

- ▶ **Deburring of edges and bore diameters and workpieces with the most different contours**
- ▶ **Processing of workpieces made of steel, hardened steel, aluminium, non-ferrous metal and plastics**
- ▶ **Processing of close slots, small breaches and difficult to access places**



Features

- ✔ Robust construction
- ✔ Low weight
- ✔ 360° swivelling grinding arm

Options

- ✔ Grinding belts in different grain sizes

Delivery contents

- ✔ 3 x grinding belt 330 x 10 mm (only by DHB 330)
- ✔ 3 x grinding belt 520 x 20 mm (only by DHB 520)
- ✔ Allen key 4 mm

Technical data

	DHB 330	DHB 520
Motor	0.75 kW 16 000 U/min	1.0 kW 16 000 U/min
Compressed air	6 bar	6 bar
Loudness	84 dB	84 dB
Grinding belt	330 x 10 mm	520 x 20 mm
Weight	0.83 kg	1.25 kg
No.	60438	61542

AG 360 | AG 460 | GDS 009 | 101-E

Pneumatic Grinder

The lightweight and handy air grinders are ideal for both the rough and the fine use. Confined spaces and every 3D-shapes can be processed using various grinding tools and rotary burrs.

AG 360

AG 460

GDS 009

101-E

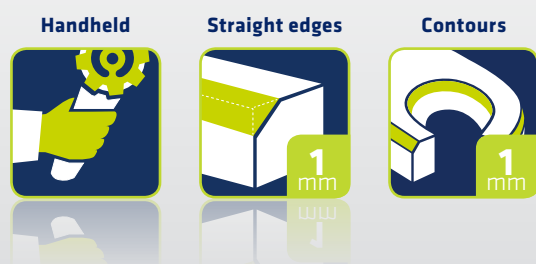

Further accessories can be found in our **Accessory Catalogue**.

Application

- ▶ **Deburring of edges and bore diameters and workpieces with the most different contours**
- ▶ **Processing of workpieces made of steel, hardened steel, aluminium, non-ferrous metal and plastics**
- ▶ **Processing of close slots, small breaches and difficult to access places**



Features

- ✔ Lightweight
- ✔ Easy handling
- ✔ High capacity and durability
- ✔ Large selection of materials
- ✔ Different grinding tools
- ✔ Tool change within a few seconds

Options

- ✔ Collet \varnothing 2.35 mm
- ✔ Carbide rotary burrs

Delivery contents

- ✔ Compressed and exhaust air hose
- ✔ Collet \varnothing 3 mm
- ✔ Collet \varnothing 6 mm (only for AG 460)
- ✔ Collet key
- ✔ Locking wrench
- ✔ Operating instructions

Technical data

	AG 360	AG 460	GDS 009	101-E
Motor	0.07 kW 60 000 rpm	0.15 kW 35 000 rpm	0.09 kW 100 000 rpm	0.09 kW 48 000 rpm
Compressed air	6 bar	6 bar	6.3 bar	4 bar
Loudness	81 dB	81 dB	72 dB	65 dB
Collet chuck	\varnothing 3 mm	\varnothing 6 mm	\varnothing 3 mm	\varnothing 3 mm
Weight	0.14 kg	0.17 kg	0.2 kg	0.1 kg
No.	42414	42727	31676	45856

MTQ 100 MH | F3 | F6 | S3 | MT W

Electric Grinder

The handy and powerful electric grinders are optimally suited for individual applications for deburring, cutting, grinding and polishing. Confined spaces and every 3D-shapes can be processed using various grinding tools and rotary burrs.



Control unit MT50

Handheld



Straight edges



Contours



F6: 3 mm
F3, S3, MT W: 2 mm
MTQ 100 MH: 1 mm

F6: 3 mm
F3, S3, MT W: 2 mm
MTQ 100 MH: 1 mm



Further accessories can be found in our **Accessory Catalogue**.

Application

- ▶ Ideal tool for deburring, cutting, grinding and polishing
- ▶ Processing of workpieces made of steel, hardened steel, aluminium, non-ferrous metal and plastics
- ▶ Processing of close slots, small breaches and difficult to access places





Professional advantages

- ▶ Very handy by lightweight and compact motor. Wrist protection by extremely balanced hand motor
- ▶ Large selection of tools
- ▶ Tool change within a few seconds
- ▶ Sight protection glass with LED and with gooseneck magnetic base or mechanical fixture

Features

- ✔ Easy handling
- ✔ Smooth running, even at 100,000 rpm
- ✔ High torque in all rpms
- ✔ Quick tool exchange without key at S3, F3, MTQ
- ✔ High machine lifetime
- ✔ Freely selectable combination of control unit and motor handpiece
- ✔ Made in Germany

Options

- ✔ Customized collets up to \varnothing 6 mm
- ✔ Foot switch
- ✔ Angle handpiece 50° & 90° (MT W only)
- ✔ Carbide rotary burr
- ✔ Corundum, CBN and diamond grinding tools
- ✔ Polishing tools
- ✔ Control Unit MT40, MT50 or MTQ/100

Delivery contents

- ✔ Collet \varnothing 3 mm (F3, S3, MT W & MTQ 100 MH)
- ✔ Collet \varnothing 6 mm (F6 only)
- ✔ Collet quick connector (F6 only)
- ✔ Locking wrench (F6 only)
- ✔ Handpiece holder
- ✔ Operating instructions

Technical data

	MT40	MT50	MTQ/100	MTQ/100 MH	F3 S3	F6	MTW
Rotational speed	0 - 40 000 rpm	0 - 50 000 rpm	0 - 100 000 rpm	-	-	-	-
Torque	7.5 Ncm	9.0 Ncm	4.0 Ncm	-	-	-	-
Energy	240 V, 50/60 Hz	240 V, 50/60 Hz	240 V, 50/60 Hz	-	-	-	-
Collet chuck	-	-	-	\varnothing 3 mm	\varnothing 3 mm	\varnothing 6 mm	\varnothing 3 mm
Weight	-	-	-	0.33 kg	0.24 0.36 kg	0.23 kg	0.14 kg
Control Unit	-	-	-	MTQ/100	MT40 or MT50	MT40 or MT50	MT50
No.	20578	20585	66362	66363	19534 68442	63367	27303

ASO 300 | ASO 310

Chamfering Machine, handheld, pneumatic

The pneumatic, handheld chamfering machines are an ideal solution for deburring straight edges and contours on flat workpieces. Especially one hand processing is a great advantage. Restroot must be at least 2 mm.

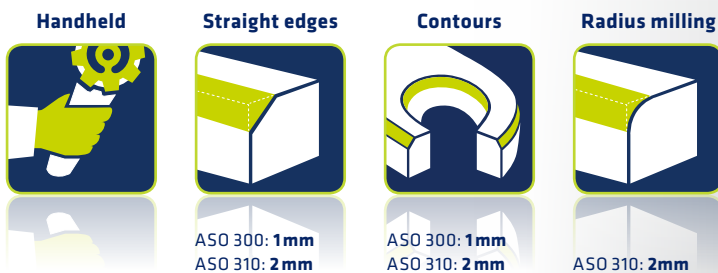

Further accessories can be found in our **Accessory Catalogue**.

Application

- ▶ For large and heavy workpieces
- ▶ 45° chamfering of flat workpieces made of steel up to 1 000 N/mm², aluminium, brass, copper, plastics, acrylic glass, wood and much more
- ▶ Pre-dominantly for contours but also for straight edges
- ▶ For rounding edges (only ASO 310)
- ▶ Bores with $\varnothing > 6$ mm can be processed



Features

- ✔ Absolutely burr-free cutting
- ✔ Clean and consistent processing of component parts and series
- ✔ Fast convert or replace of the carbide-cutting inserts
- ✔ Suitable for continuous operation

Options

- ✔ Radius inserts R1 – R2 mm
- ✔ A special roller bearing for sheet thickness between 2-5 mm (only for ASO 310)
- ✔ Plastic disk for scratch-free surfaces

Delivery contents

- ✔ Hook spanner $\varnothing 58 - 65$ mm
- ✔ Torx key T 9
- ✔ Setting gauge
- ✔ Cutter head with cutting inserts
- ✔ Compressed air hose without nipple
- ✔ Operating instructions

Technical data

	ASO 300	ASO 310
Motor	0.15 m ³ /min. 28 000 rpm	0.4 m ³ /min 13 000 rpm
Energy	6 bar	6 bar
Max. chamfer width	1 mm	2 mm
Guide ball bearing	min. $\varnothing 6$ mm	min. $\varnothing 11$ mm
Cutter head	45°	45°
Weight	0.5 kg	1.8 kg
No.	61881	20039

ASO 313 | ASO 312

Chamfering Machine, handheld, electric | pneumatic

The compact and robust, handheld chamfering machines are particularly suitable for chamfering straight edges on flat workpieces even with outstanding burrs. Stable, screwed cutting inserts guarantee long tool life. Restroot must be at least 1 mm.

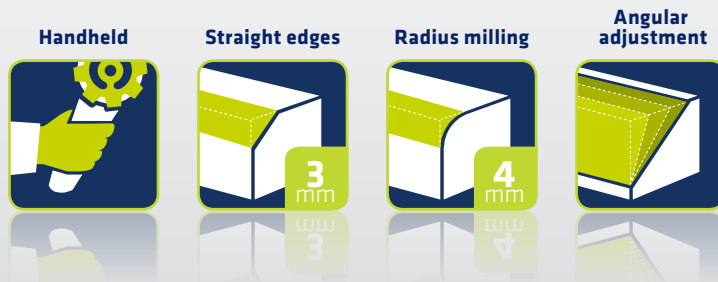

Further accessories can be found in our **Accessory Catalogue**.

Application

- ▶ For large and heavy workpieces
- ▶ Chamfering of flat workpieces made of steel, stainless steel, cast iron, aluminum, brass and plastics
- ▶ Chamfering of straight edges in different angles
- ▶ Rounding edges



Features

- ✔ Absolutely burr-free cutting
- ✔ Clean and consistent processing of component parts and series
- ✔ Fast retrofit or replace of the carbide-cutting inserts
- ✔ Wear-resisting, hardened guide rails
- ✔ Long useful life of the cutting inserts
- ✔ Adjustable according to right- or left-hander
- ✔ Angle-adjustable rails

Options

- ✔ Radius inserts R2 - R4 mm

Delivery contents

- ✔ Allen key 3 mm
- ✔ Allen key 4 mm (only with ASO 313)
- ✔ Torx key T 15
- ✔ Handle grip
- ✔ Cutter head with cutting inserts
- ✔ Swarf box (only with ASO 313)
- ✔ Operating instructions

Technical data

	ASO 312	ASO 313
Motor	0.5 kW 13 000 rpm	0.9 kW 10 000 rpm
Energy	6 bar	230 V, 50/60 Hz
Max. chamfer width	3 mm	3 mm
Guide rails	hardened	hardened
Angular adjustment	15° - 45°	15° - 45°
Weight	2.9 kg	3.4 kg
No.	26153	32938

SMA 20-EF24 | SMA 20-PF25

Chamfering Machine, handheld, electric | pneumatic

The electric, handheld chamfering machines are an ideal solution for deburring contours and also straight edges on even and flat materials. Two-hand operation with ergonomic handle enables stable and safe deburring and bevelling. Restroot must be at least 2 mm.



SMA 20-EF24

SMA 20-PF25

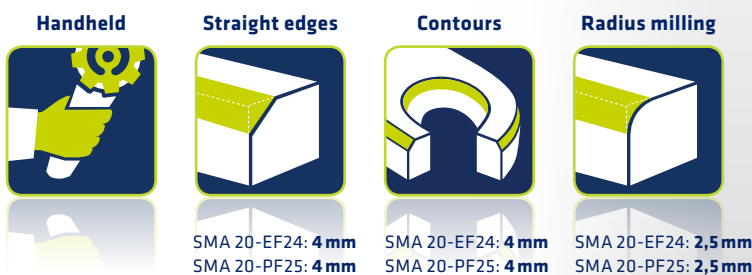

Handheld

Straight edges

Contours

Radius milling

SMA 20-EF24: 4 mm
SMA 20-PF25: 4 mm

SMA 20-EF24: 4 mm
SMA 20-PF25: 4 mm

SMA 20-EF24: 2,5 mm
SMA 20-PF25: 2,5 mm



Further accessories can be found in our **Accessory Catalogue**.

Application

- ▶ For large und heavy workpieces
- ▶ Chamfering of flat workpieces made of steel, stainless steel, cast iron, non-ferrous metals and plastics
- ▶ Chamfering of contours and also straight edges
- ▶ Rounding edges

Features

- ⊕ Absolutely burr-free cutting
- ⊕ Adaptable, also at difficult contours
- ⊕ Clean and consistent processing of component parts and series
- ⊕ Fast convert or replace of the carbide-cutting insert
- ⊕ Small cutter head with cutting inserts also for bores from $\varnothing 19,4$ mm
- ⊕ Very economic insert price, because of 8 usable cuts per insert

Options

- ⊕ Radius inserts R1,2 – R2,5 mm

Delivery contents

- ⊕ Copper paste
- ⊕ Torx key T 15
- ⊕ Operating instructions



Technical data

	SMA 20-EF24 ⊕	SMA 20-PF25 ⊕
Motor	1.2 kW 11 000 rpm	0.67 kW 12 000 rpm
Energy	230 V, 50/60 Hz	6-7 bar
Max. chamfer width	4 mm	4 mm
Guide ball bearing	min. $\varnothing 19,4$ mm	min. $\varnothing 19,4$ mm
Cutter head	45°	45°
Weight	2.95 kg	2.95 kg
No.	65694	68409

SMA 30-EVR24 | SMA 30-PV25

Chamfering Machine, handheld, electric | pneumatic

The pneumatic, handheld chamfering machines are an ideal solution for bevelling internal and external edges and contours as well as bores.

A wide range of accessories allows a stable, secure and vibration-free chamfering of different materials. Restroot must be at least 2 mm.



SMA 30-EVR24

SMA 30-PV25



SMA 30-EVR24: 6 mm SMA 30-EVR24: 6 mm SMA 30-EVR24: 6 mm
SMA 30-PV25: 6 mm SMA 30-PV25: 6 mm SMA 30-PV25: 6 mm



Further accessories can be found in our **Accessory Catalogue**.

Application

- ▶ For large und heavy workpieces
- ▶ Chamfering of flat workpieces made of steel, stainless steel, cast iron, aluminum, brass and plastics
- ▶ Chamfering of contours and also straight edges
- ▶ Rounding edges
- ▶ Air pressure machine more suitable for continuous work



Features

- ✔ Absolutely burr-free cutting
- ✔ Exact adjustment due to existing scale
- ✔ Small cutter head with cutting inserts also for bores from 10 mm
- ✔ Low tool costs-each insert has 8 cuts
- ✔ Long useful life due to stable, screwed cutting inserts

Options

- ✔ Radius inserts R1,2 – R6 mm
- ✔ Cutter heads with various angular degrees

Delivery contents

- ✔ Allen key 3 mm
- ✔ Torx key T 15
- ✔ Tool box
- ✔ Operating instructions

Technical data

	SMA 30-EVR24	SMA 30-PV25
Motor	1.5 kW 2 500 - 7 900 rpm	1.04 kW 12 000 rpm
Energy	230 V, 50/60 Hz	6 - 7 bar
Max. chamfer width	6 mm	6 mm
Guide ball bearing	min. ø 10 mm	min. ø 10 mm
Cutter head	30° / 45° / 60°	30° / 45° / 60°
Weight	3.5 kg	3.0 kg
No.	66005	67054

SMA 40-E | SMA 50-E | SMA 40-P

Chamfering Machine, handheld, electric | pneumatic

Apart from the rapid chamfer retooling system for efficient and economic use, the chamfering machines have also a spring technology for smooth and insert protecting cut. Internal and external edges, contours and bores on flat material can be machined in vibration-free operation.



Handheld



Straight edges



Contours



Radius milling



Angular adjustment

SMA 40-E: 12 mm
SMA 50-E: 15 mm
SMA 40-P: 12 mm

SMA 40-E: 12 mm
SMA 50-E: 15 mm
SMA 40-P: 12 mm

SMA 40-E: 8 mm
SMA 50-E: 8 mm
SMA 40-P: 8 mm

Further accessories can be found in our **Accessory Catalogue**.

Application

- ▶ For large and heavy workpieces
- ▶ Chamfering of flat workpieces made of steel, stainless steel, cast iron, aluminum, brass, and plastics
- ▶ Chamfering of contours and also straight edges
- ▶ Rounding edges
- ▶ For preparing weld seams



Features

- ✔ Absolutely burr-free cutting
- ✔ Proper processing for welding preparation
- ✔ Efficient chamfer retooling system
- ✔ Special spring technology saves the tools
- ✔ Better tool life for cutting inserts
- ✔ Ergonomic two-hand operation

Options

- ✔ Radius cutter and radius inserts from R2 – R8 mm
- ✔ Cutter heads in various angular degrees
- ✔ Guide ruler for straight edges
- ✔ 3D - swivel arm

Delivery contents

- ✔ Allen key 5 mm
- ✔ Torx key T 15
- ✔ Tool box
- ✔ Operating instructions

Technical data

	SMA 40-E	SMA 50-E	SMA 40-P
Motor	1.5 kW 2 500 - 7 500 rpm	2.2 kW 2 300 - 7 000 rpm	1.9 kW 6 600 rpm
Energy	230 V, 50/60Hz	230 V, 50/60 Hz	6 - 7 bar
Max. chamfer width	12 mm	15 mm	12 mm
Cutter head	0° - 80°	0° - 80°	0° - 80°
Guide ball bearing	min. ø 28.7 mm	min. ø 28.7 mm	min. ø 28.7 mm
Weight	6 kg	9 kg	4.5 kg
No.	53206	51325	51506

SMA 60-EVS

Chamfering Machine, handheld, electric

Most powerful hand machine center for hand use. Highly advanced technology allow large bevells in a soft and smooth cut - even in one pass.



SMA 60-EVS



Further accessories can be found in our **Accessory Catalogue**.

Application

- ▶ For large and heavy workpieces
- ▶ Chamfering of flat workpieces made of steel, stainless steel, cast iron, aluminum, brass, and plastics
- ▶ Chamfering of contours and straight edges
- ▶ Rounding edges
- ▶ For preparing weld seams



Features

- ✔ Absolutely burr-free cutting
- ✔ Proper processing for welding preparation
- ✔ Efficient chamfer retooling system
- ✔ Special spring and mass technology allows a heavy and soft cut
- ✔ Better tool life for inserts and cutter
- ✔ Ergonomic two-hand operation

Options

- ✔ Radius cutter and radius inserts from R1,2 – R15 mm
- ✔ Cutter heads in various angular degrees
- ✔ Guide ruler for straight edges
- ✔ 3D-swivel arm for ease of operation

Delivery contents

- ✔ Allen key 5 mm
- ✔ Torx key T 15
- ✔ Tool box
- ✔ Operating instructions

Technical data

	SMA 60-EVS
Motor	2.5 kW 6 600 rpm
Energy	230 V, 50/60 Hz
Max. chamfer width	20 mm
Cutter head	0° – 80°
Guide ball bearing	min. ø 28.7 mm
Weight	11 kg
No.	69204

ASO 750 | ASO 760-2

Chamfering Machine, Deburring Machine, handheld, electric

The compact and robust handheld chamfering machines are particularly suitable for preparing weld seams of large workpieces.

Simple handling of the machines ensures optimal selection of weld seam preparation at straight edges and round plates.

The milling angle is adjustable and the chamfer height can be set.



ASO 750

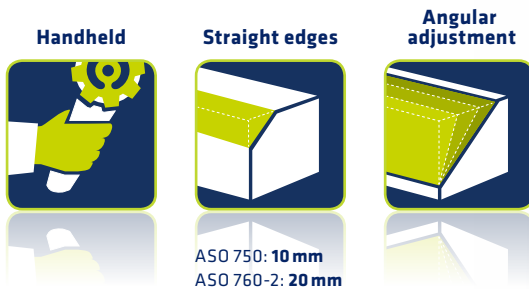

ASO 750: 10 mm
ASO 760-2: 20 mm



Further accessories can be found in our **Accessory Catalogue**.

Application

- ▶ For large and heavy workpieces
- ▶ Suitable for sturdy continuous operation with manual feed
- ▶ For preparing weld seams
- ▶ Ideal for chamfering at steel and non-ferrous metal

Features

- ⚙ Simple chamfer and angle adjustment
- ⚙ Wearresisting, hardened guide
- ⚙ Guide plates with rollers for easy pushing (only ASO 760-2)
- ⚙ Sturdy casting construction with ergonomic handle

Options

- ⚙ Fixture for tubes with external diameter 150 mm and more

Delivery contents

- ⚙ Allen keys 4 and 5 mm
- ⚙ Cutter head with cutting inserts
- ⚙ Electric cable without plug
- ⚙ Operating instructions



Technical data

	ASO 750 ⚙	ASO 760-2 ⚙
Motor	0.95 kW 2 900 rpm	1.2 kW 2 900 rpm
Energy	400 V, 50 Hz	400 V, 50 Hz
Max. Chamfer width	10 mm	20 mm
Angular adjustment	15° - 45°	15° - 60°
Guide rails	hardened	hardened with guide rollers
Dimensions (LxWxH)	380 × 200 × 240 mm	380 × 290 × 310 mm
Weight	13 kg	19.5 kg
No.	10304	10670

ASO 760-3

Chamfering Machine, Deburring Machine, handheld, electric

The compact handheld chamfering machine is particularly suitable for weld seam preparation of large workpieces.

The new, 3-row cutter head with screwed cutting inserts is advantageous for heavy cuts in aluminium or stainless.

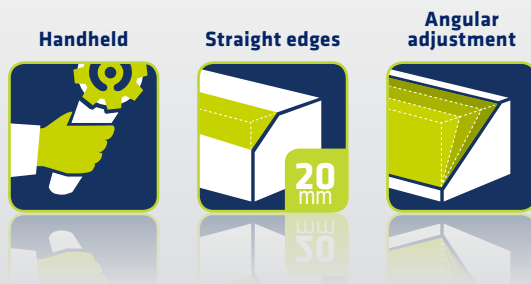

Further accessories can be found in our **Accessory Catalogue**.

Application

- ▶ Suitable for sturdy continuous operation with manual feed
- ▶ For preparing weld seams
- ▶ Ideal for chamfering at steel, stainless steel and non-ferrous metals

Features

- ✔ Simple chamfer and angle adjustment
- ✔ Wear resisting, hardened guide plates with rollers for easy pushing
- ✔ Sturdy cast-iron construction with ergonomic handle

Options

- ✔ Fixture for tubes with external diameter 150 mm and more

Delivery contents

- ✔ Allen keys 4 and 5 mm
- ✔ Torx key T 15
- ✔ Cutter head with cutting inserts
- ✔ Electric cable without plug
- ✔ Operating instructions



Technical data

ASO 760-3 ✔

Motor	1.2 kW 2 900 rpm
Energy	400 V, 50 Hz
Max. chamfer width	20 mm
Angular adjustment	15° – 60°
Guide rails	hardened with guide rollers
Dimensions (LxWxH)	380 × 290 × 310 mm
Weight	19.5 kg
No.	10249

KBM 18

Chamfering Machine, selfpropelling

The automatic chamfering machine for rough shearing of edges by means of a cutting wheel is ideal for quick and noiseless bevelling. It can be used stationary or portable.

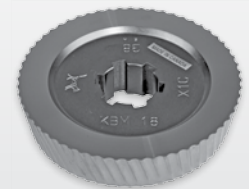
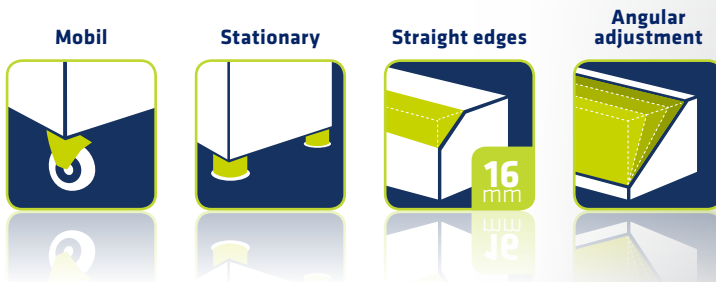

Further accessories can be found in our **Accessory Catalogue**.

Application

- ▶ Workpieces > 200 x 60 x 6 mm
- ▶ Fastest chamfering with lowest noise at metal sheets and plates
- ▶ Weld seam preparation V-, X-, K- or Y-seam
- ▶ Universally applicable for almost all metals up to 700N/cm²



Features

- ⌚ Automatic feed
- ⌚ Easy angle adjustment
- ⌚ Easy operation and setting
- ⌚ Sturdy construction

Options

- ⌚ Chamfer cutter for steel / stainless steel
- ⌚ Mobile undercarriage with height adjustment

Delivery contents

- ⌚ Standard accessories
- ⌚ Universal milling cutter 30°
- ⌚ Electric cable without plug
- ⌚ Operating instructions

Technical data

KBM 18 ⌚

Motor	1.5 kW
Energy	400 V, 50/60 Hz
Max. chamfer width	16 mm
Plate thickness	6 - 38 mm
Plate width	> 80 mm
Plate length	> 200 mm
Chamfer angle	22.5° / 30° / 37.5° / 45° / 55°
No.	37422

Quicker | Maxiquicker

Chamfering Machine, selfpropelling

The automatic chamfering machines Quicker | Maxiquicker are designed for the stationary and portable use in weld seam preparation. A cutting wheel shears off the edge in a low-noise and dust-free way, leaving a rough chamfer. High feed rate.

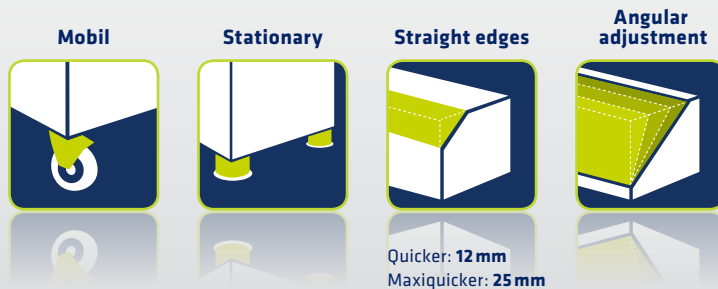

Further accessories can be found in our **Accessory Catalogue**.

Application

- ▶ Workpieces > 200 x 60 x 6 mm
- ▶ Fastest chamfering with lowest noise at metal sheets and plates
- ▶ In combination with an undercarriage, the machine independently bevels along the milling edge
- ▶ Weld seam preparation V-, X-, K- or Y-seam
- ▶ Universally applicable for almost all metals up to 700 N/cm²



Features

- ✔ Automatic feed
- ✔ Easy angle adjustment
- ✔ Easy operation and setting
- ✔ High feed rate with low noise
- ✔ Sturdy construction

Options

- ✔ Mobile undercarriage with height adjustment
- ✔ Chamfer cutter for steel / stainless steel

Delivery contents

- ✔ Standard accessories
- ✔ Universal milling cutter 30°
- ✔ Electric cable without plug
- ✔ Operating instructions

Technical data

	Quicker	Maxiquicker
Motor	1.5 kW	2.2 kW
Energy	400 V, 50/60 Hz	400 V, 50/60 Hz
Max. chamfer width	12 mm	25 mm
Plate thickness	6 – 40 mm	8 – 50 mm
Plate width	> 80 mm	> 80 mm
Plate length	> 200 mm	> 200 mm
Chamfer angle	22.5° – 50°	22.5° – 50°
No.	28582	37935

ASO 900 | ASO 900 Plus | ASO 900 Plus-Bigger

Chamfering Machine, selfpropelling

Large size workpieces or long bars with angles from 15° - 60° can be machined easily in heavy cuts. Extremely good tool life is the result of low revolution milling. Even materials like hardox, tank steels or stainless steels are economically cut.

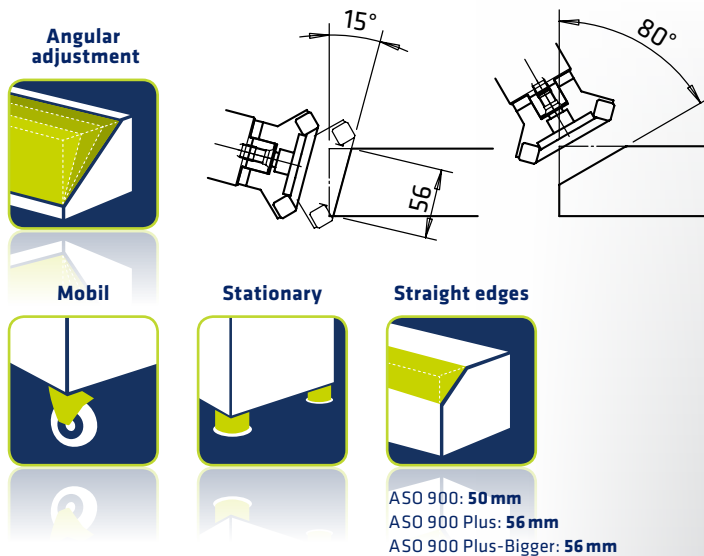

ASO 900 Plus-Bigger



Further accessories can be found in our **Accessory Catalogue**.

Application

- ▶ Workpieces > 200 x 60 x 8 mm
- ▶ Especially suitable for heavy, long and large-size workpieces
- ▶ Universal for all materials, suitable for continuous operation
- ▶ Mobile operation of roller carriage or with crane support or stationary



Features

- ✔ Best tool life also in stainless steel
- ✔ The setting of angle and also of plate thickness is easily done
- ✔ Automatic feed adjustment depending on the relevant material from 0 - 1 m/min.
- ✔ Sturdy cast iron/steel construction, hardened work table with guide rollers
- ✔ Working height 800 - 980 mm

Options

- ✔ Different cutters according to application
- ✔ Speed regulation
- ✔ Automatic height adjustment according to plate thickness
- ✔ Special version for workpiece thicknesses: 8 - 100 mm or 8 - 200 mm or < 8 mm

Delivery contents

- ✔ Allen key 8 and 10 mm
- ✔ Electric cable without plug
- ✔ Operating instructions

Technical data

	ASO 900	ASO 900 Plus	ASO 900 Plus-Bigger
Motor	4.0 kW 750 rpm	4.0 kW 750 rpm	5.5 kW 0-750 rpm
Energy	400 V, 50/60Hz	400 V, 50/60Hz	400 V, 50/60Hz
Max. chamfer width	50 mm	56 mm	56 mm
Angular adjustment	15° - 60°	15° - 80°	15° - 80°
Automatic feed	0 - 1 m/min	0 - 1 m/min	0 - 1 m/min
Work piece thickness	8 - 50 mm	8 - 60 mm	4 - 100 mm
Weight	175 kg	215 kg	310 kg
No.	42699	63133	64909

ASO 930 | ASO 930 Plus

Chamfering Machine, selfpropelling

With the ASO 930 | ASO 930 Plus milling the front- and bottom side on the workpiece is now possible. The turning of the workpiece is no longer necessary.

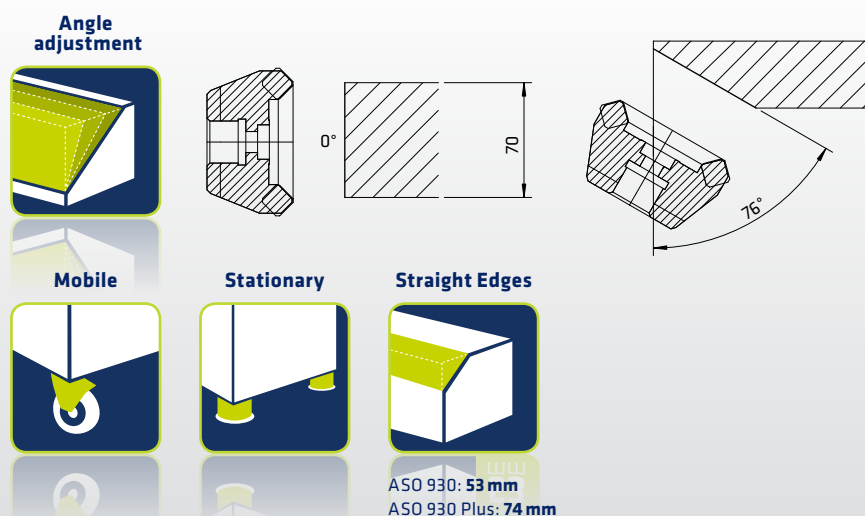

ASO 930



Further accessories can be found in our **Accessory Catalogue**.

Application

- ▶ Especially for heavy, long and large-area workpieces
- ▶ Front- and bottom side surface milling at an angle of 0° - 76° with milling widths up to 74 mm
- ▶ Preferred for mobile use on a roller carriage, but also with crane support or stationary

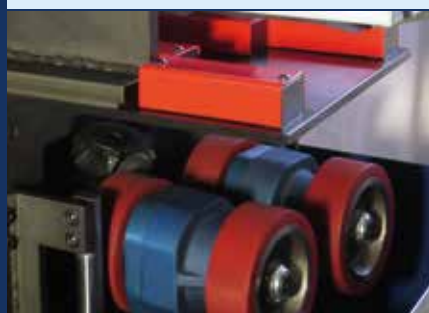

Features

- ⌚ Simple bevel- and angle adjustment
- ⌚ Automatic feed regulation depending on the material of 0 - 1.2 m/min
- ⌚ Sturdy cast iron construction
- ⌚ Hardened worktable with guide rollers
- ⌚ Working height 820 - 970 mm

Options

- ⌚ Speed regulation
- ⌚ Roughing cutter head RC16 or SN16
- ⌚ Cutter head WSX for workpieces < 8 mm and smaller bevels
- ⌚ Special version for workpiece thicknesses: 8 - 100 mm or < 8 mm

Delivery contents

- ⌚ Allen key of 8 mm and 10 mm
- ⌚ Electric cable without plug
- ⌚ Operating instructions

Specifications

	ASO 930 ⌚	ASO 930 Plus ⌚
Motor	4.0 kW 800 rpm	5.5 kW 700 rpm
Energy	400 V, 50/60Hz	400 V, 50/60Hz
Max. chamfer width	53 mm	74 mm
Angle adjustment	0° - 60°	0° - 76°
Workpiece thickness	8 - 60 mm	8 - 70 mm
Weight	240 kg	400 kg
No.	60269	67019

ASO 910

Chamfering Machine, selfpropelling

Recess chamfering or the removal of cladding of large sheets is mastered excellently by the automatic chamfering machine ASO 910. Thanks to its robust version, the machine achieves a chamfer width up to 50 mm and a chamfer depth up to 15 mm. The machine is unique in this performance category.

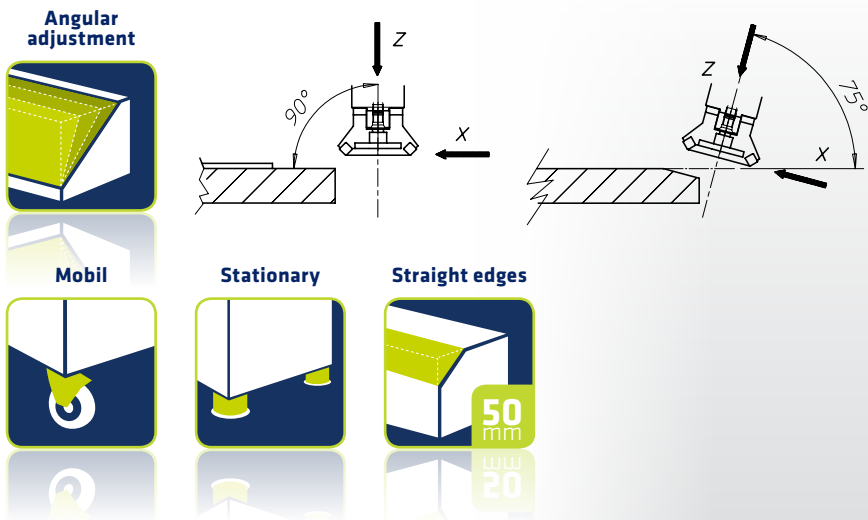

Further accessories can be found in our **Accessory Catalogue**.

Application

- ▶ Especially suitable for heavy, long and extensive workpieces
- ▶ This machine is universal for all materials and suitable for continuous operation
- ▶ Recess chamfering or slight bevelling at angles of 90° - 75° regarding the perpendicular
- ▶ Mobile operation of roller carriage or with crane support or stationary



Features

- ⌚ Feed in X- and Z-axis, as well chamfer angle is easily adjusted
- ⌚ Automatic feed adjustment depending on the relevant material from 0 - 1 m/min.
- ⌚ Sturdy cast iron/steel construction, hardened work table with guide rollers
- ⌚ Working height 930 - 1 120 mm

Options

- ⌚ Speed regulation
- ⌚ Face-milling, square shoulder or radius chamfer can be used, depending on the relevant recess outlet
- ⌚ Special version for workpiece thicknesses: 6 - 200 mm
- ⌚ Special version for wider thickness range from 6 - 200 mm is needed
- ⌚ Extension of the axis adjustment up to 100 mm

Delivery contents

- ⌚ Allen key 8 and 10 mm
- ⌚ Electric cable without plug
- ⌚ Operating instructions

ASO 910 ⌚

Technische Daten

Motor	4.0 kW 0 - 900 rpm
Energy	400 V, 50/60 Hz
max. feed in X- / Z-axis	50 mm / 15 mm
Angular adjustment	90° - 75°
Workpiece thickness	8 - 100 mm
Weight	385 kg
No.	54235

ASO 920

Chamfering Machine, selfpropelling

The largest welding chamfers - in tulip shape - can be cut efficiently with the ASO 920. This automatic chamfering machine convinces in this league of performance.

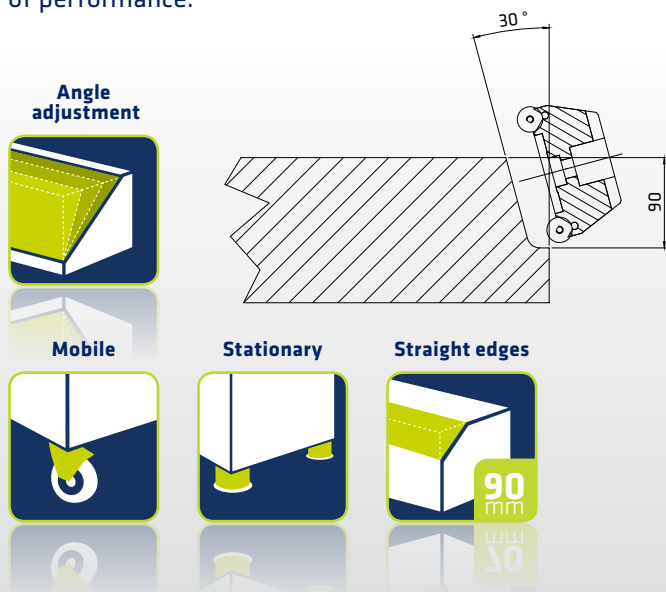

Further accessories can be found in our **Accessory Catalogue**.

Application

- ▶ Especially for heavy, long and large-area workpieces
- ▶ Universally suited for all kinds of material and for continuous operation
- ▶ Tulip shape-milling at an angle of 0° - 30° with respect to the vertical
- ▶ Preferred for mobile use on a roller carriage, but also with crane support or stationary



Features

- ✔ Simple chamfer- and angle adjustment
- ✔ Automatic feed regulation depending on the material of 0 - 1.2 m/min
- ✔ Infeed in Z up to max. 90 mm is possible
- ✔ Infeed in X up to max. 55 mm is possible
- ✔ Sturdy cast iron construction, hardened work table with guide rollers
- ✔ Working height 920 - 1110 mm

Delivery contents

- ✔ Allen key of 8 mm and 10 mm
- ✔ Electric cable without plug
- ✔ Operating instructions

Specifications

ASO 920

Motor	5.5 kW 0 - 900 rpm
Energy	400 V, 50/60Hz
Max. adjustment in X-/Z-axis	55 mm / 90 mm
Angle adjustment	0° - 30° regarding the perpendicular
Workpiece thickness	8 - 100 mm
Weight	480 kg
No.	58725

BKE 550

Sheet Deburring Machine

The compact plate deburring machine is suitable for deburring of straight plate edges.

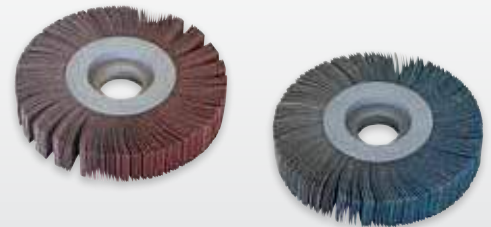

Further accessories can be found in our **Accessory Catalogue**.

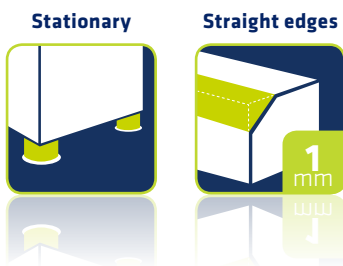

Application

- ▶ **Fast deburring on both sides in one operation**
- ▶ **For small sheets in horizontal operation and large sheets in vertical operation**
- ▶ **Universal for all materials from 1 - 5 mm thickness**



Features

- ⌚ Sturdy sustainable sheet construction with exhauster
- ⌚ Grinding wheels readjustable via hand wheel
- ⌚ Quick plate thickness adjustment by screws
- ⌚ Easy handling and fast tool change

Options

- ⌚ Flap wheels for steel and stainless steel with different grain sizes
- ⌚ Dust extraction

Delivery contents

- ⌚ Longitudinal stop
- ⌚ 2 flap wheels
- ⌚ Extraction socket
- ⌚ Operating instructions

Technical data

BKE 550 ⌚

Motor	0.2 kW 1 400 rpm
Energy	400 V, 50 Hz
Max. chamfer width	1 mm
Sheet thickness	1 - 5 mm
Dimensions (L×W×H)	550 × 380 × 400 mm
Weight	38 kg
No.	45373

AF 165

Beveling Machine with Sanding Disc

Very efficient in removing saw burrs and sharp edges. Workpieces can be handled and processed safely. Fast and cost effective deburring. The tool life of flap discs or CBN/Diamond grinding wheels is rather economic.

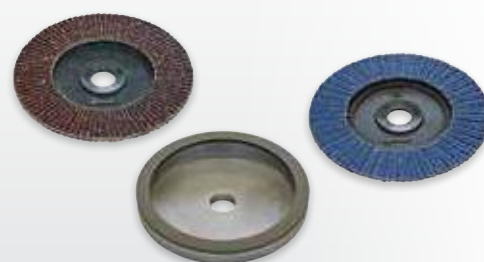

Further accessories can be found in our **Accessory Catalogue**.

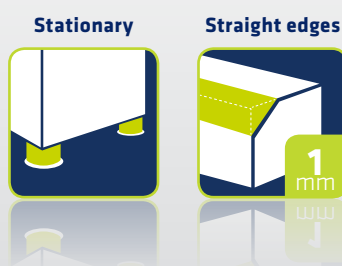

Application

- ▶ **Minimum workpiece thickness 3 mm**
- ▶ **Can be used for steel, hardened steel, aluminium, brass, copper, plastic, from soft plastic to acrylic glass, wood and much more**

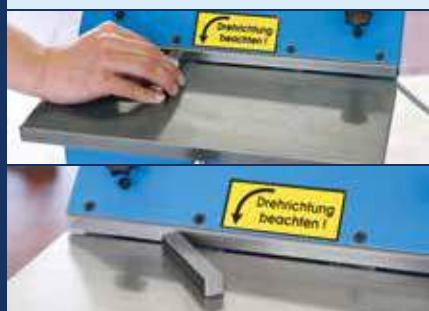

Features

- ✔ Easy operation
- ✔ Uncomplicated tool change
- ✔ Freely adjustable chamfer adjustment
- ✔ Hardened guide rails
- ✔ Clean working place due to exhauster

Options

- ✔ Table extension
- ✔ Dust extraction
- ✔ Flap disks for steel or stainless steel with different grain sizes
- ✔ CBN- and diamond grinding wheels

Delivery contents

- ✔ Flap disks with special bond K80
- ✔ Extraction socket \varnothing outside 37,1 mm / \varnothing inside 32 mm
- ✔ Operating instructions

Technical data

AF 165

Motor	0.37 kW 2 800 rpm
Energy	400 V, 50/60 Hz
Max. chamfer width	1 mm
Flap disk	\varnothing 165 mm
Dimensions (L×W×H)	370 × 520 × 320 mm
Weight	25 kg
No.	19281

KSM 125 | KSM 130

Chamfer Grinding Machine for Straight Edges

Suitable for precise deburring and chamfering of straight edges at hardened steel. It is available with wet-grinding or dust extraction device.

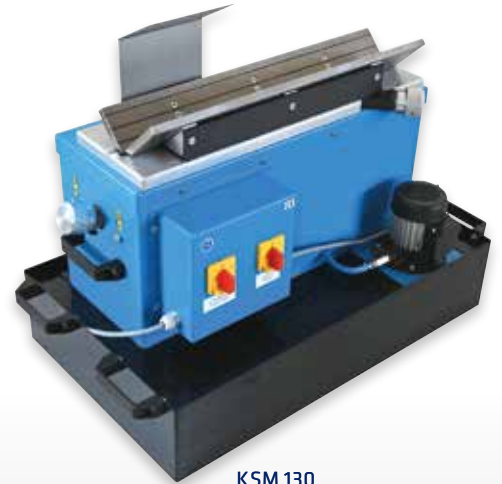

KSM 130



KSM 125

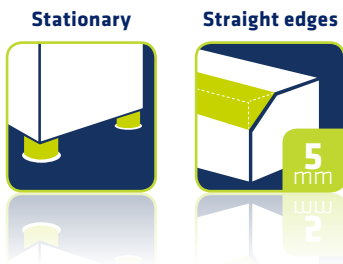

Further accessories can be found in our **Accessory Catalogue**.

Application

- **Soft and hard materials up to 63 HRC**

Features

- ☑ Sturdy construction with grinding disk adjusting button
- ☑ Water cooling provides workpiece and grinding disk
- ☑ V-Prism with micrometer chamfer adjustment
- ☑ Sturdy conical 2-zone grinding disk for strong material removal

Options

- ☑ Mobile undercarriage

Delivery contents

- ☑ Standard accessories
- ☑ Grinding disk
- ☑ Operating instructions
- ☑ Extraction socket (KSM 125)
- ☑ Water tub and pump (KSM 130)



Technical data

	KSM 125 ☑	KSM 130 ☑
Motor	0.6 kW 2 890 rpm	0.6 kW 2 890 rpm
Energy	400 V, 50/60 Hz	400 V, 50/60 Hz
Vc	700 - 1 100 m/min	700 - 1 100 m/min
Max. chamfer width	3 mm	3 mm
Grinding disk, conical	ø min. 80 mm, max. 125 mm	ø min. 80 mm, max. 125 mm
Dimensions (LxWxH)	640 × 300 × 400 mm	700 × 650 × 400 mm
Weight	70 kg	70 kg
No.	15990	60715

Speedy Prisma 210-P | Speedy Prisma 210-PSL

Deburring Machine with Sliding Carriage

This deburring machines are easy, sturdy table machines with a prismatic sliding carriage for efficient and precise processing of longitudinal edges of small workpieces.



Speedy Prisma 210-P

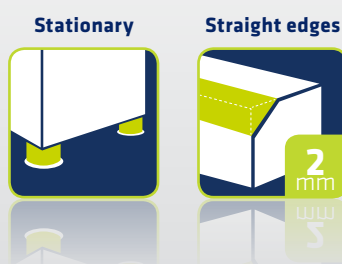

Further accessories can be found in our **Accessory Catalogue**.

Application

- ▶ Burr-free chamfering of small precision parts from 1 mm thickness in almost polished precision
- ▶ This machine is universal for all materials and suitable for continuous operation



Features

- ✔ Surface protecting precision chamfers up to 2 mm (no scratches on the surface)
- ✔ Easy operation
- ✔ Fast tool change, easy cutter setting
- ✔ Speed control for processing different materials
- ✔ Supported sliding carriage for chatter-free milling

Options

- ✔ Extraction socket (ø outside 32 mm / ø inside 20 mm)
- ✔ Extraction device

Delivery contents

- ✔ Allen key 2.5 mm
- ✔ Prism cutter
- ✔ Operating instructions

Technical data

	Speedy Prisma 210-P	Speedy Prisma 210-PSL
Motor	0.14 kW 20 000 rpm	0.14 kW 10 000 - 30 000 rpm
Energy	230 V, 50 Hz	230 V, 50 Hz
Max. chamfer width	2 mm	2 mm
Dimensions (LxWxH)	320 × 200 × 180 mm	320 × 200 × 180 mm
Weight	8 kg	9 kg
No.	57123	46069

FS 5

Beveling Machine with V-prism

The FS 5 is a sturdy and cost-effective chamfering machine with sliding cutter and tips. Straight edges of rectangular-shaped workpieces can be easily chamfered. The workpiece must be thicker than 2 mm.

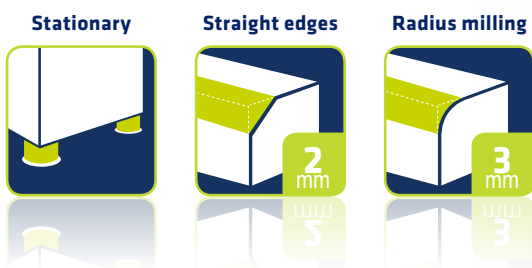

Further accessories can be found in our **Accessory Catalogue**.

Application

- ▶ Clean and burr-free chamfering in a section
- ▶ Suitable for almost all materials
- ▶ Suitable for continuous operation

Features

- ✔ Easy handling
- ✔ Sturdy guide rails
- ✔ Fast change of cutter head and cutting inserts
- ✔ Small chip box

Options

- ✔ Radius inserts from R1 – R3 mm

Delivery contents

- ✔ Cutter head with cutting inserts
- ✔ Chip box
- ✔ Operating instructions



Technical data

FS 5

Motor	0.25 kW 2 800 rpm
Energy	230 V, 50/60 Hz
Max. chamfer width	3 mm
Angular adjustment	45°
Dimensions (L×W×H)	400 × 325 × 170 mm
Weight	19 kg
No.	41408

ASO 850

Beveling Machine with V-prism for Straight Edges

The sturdy chamfering machine is designed for deburring and edge cutting of small workpieces from 2 mm thickness. Thanks to the optimised interplay of cutter head and cutting inserts, the machine ensures clatter-free, clean and constant chamfering up to 3 mm × 45° in a section, even at stainless.



Further accessories can be found in our **Accessory Catalogue**.

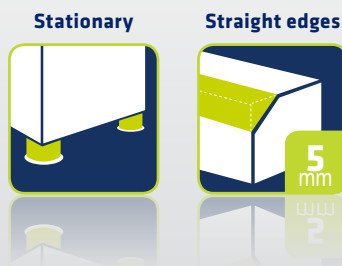

Application

- ▶ For visually beautiful 45° chamfers
- ▶ Universal for robust continuous operation



Features

- ✔ Chamfer adjustment via micrometer button
- ✔ Effortless chamfering due to low cutting pressure
- ✔ Sturdy cast iron construction with chip box
- ✔ Wear resistant, hardened and ground guide rails
- ✔ Wide variety of different cutting inserts for various materials

Options

- ✔ Mobile undercarriage
- ✔ Automatic feed
- ✔ Corundum or CBN grinding disk for hardened workpieces
- ✔ Variable speed control 0–10 000 rpm

Delivery contents

- ✔ Allen key 4 and 8 mm
- ✔ Operating instructions

Technical data

ASO 850-K

Motor	0.75 kW 0–6 000 rpm
Energy	230 V, 50/60 Hz
Max. chamfer width	5 mm
Angular adjustment	45°
Dimensions (LxWxH)	570 × 400 × 400 mm
Weight	60 kg
No.	67273

ASO 650 | ASO 650-WSL

Chamfering Machine with V-prism for Straight Edges

Deburring and chamfering of small work pieces is an easy job. Rounding of edges in use with radius inserts is also possible. Speed control is very useful when processing aluminum or stainless steel. Workpiece thickness must be more than 2 mm.

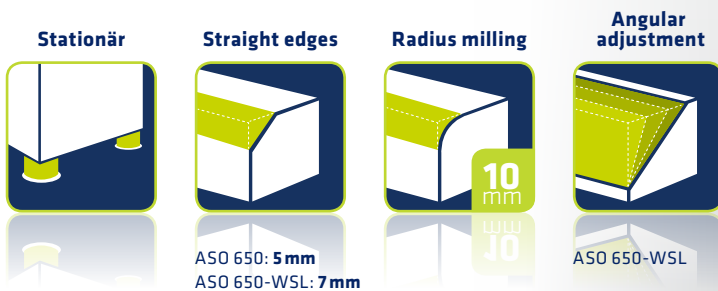

Application

- ▶ Clean and burr-free chamfering
- ▶ Suitable for sturdy continuous operation
- ▶ For preparing weld seams
- ▶ With short or thin workpieces below 5 mm, the guide rails can be turned and used with a constant 2 mm cutting gap





ASO 650

Professional advantages

- ▶ Axial cutter head adjustment for utilization of inserts by small chamfers
- ▶ Chamfer adjustment by micrometer button
- ▶ For continuous operation

Further accessories can be found in our **Accessory Catalogue**.

Features

- ✔ Sturdy cast iron construction with swarf drawer
- ✔ Wear-resistant, hardened and ground guide rails
- ✔ Precise chamfer adjustment by micrometer button in X and Z axle
- ✔ Wide variety of different cutting inserts for various materials
- ✔ Used inserts from milling machine can be used here a further time

Options

- ✔ Automatic feed
- ✔ Radius cutting inserts R1–10 mm (only with ASO 650-WSL)

Delivery contents

- ✔ Allen key 4 mm
- ✔ Side milling cutter SP 12 (only with ASO 650)
- ✔ Side milling cutter SP 15 (only with ASO 650-WSL)
- ✔ Electric cable without plug
- ✔ Operating instructions

Technical data

	ASO 650	ASO 650-WSL
Motor	0.5 kW 2 800 U/min	0.95 kW 0–6 000 rpm
Energy	400 V, 50/60 Hz	400 V, 50/60 Hz
Max. chamfer width	5 mm	7 mm
Angular adjustment	45°	15°–45°
Dimensions (LxWxH)	400 × 500 × 300 mm	400 × 500 × 300 mm
Weight	52 kg	55 kg
No.	10229	10230



ASO 650-WSL

ASO 160-S | ASO 160-SSL

Chamfering Machine with V-prism for Straight Edges

Whether individual parts or series production, the ASO 160-S | SSL is an indispensable assistant in all metalworking operations.

You can easily process both small parts and bars.

The optically polished looking chamfer surfaces represent the skill of the machine.

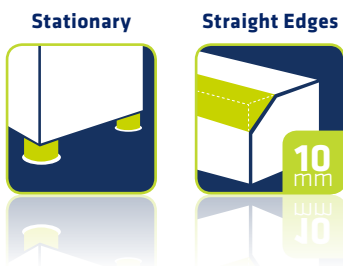

Further accessories can be found in our **Accessory Catalogue**.

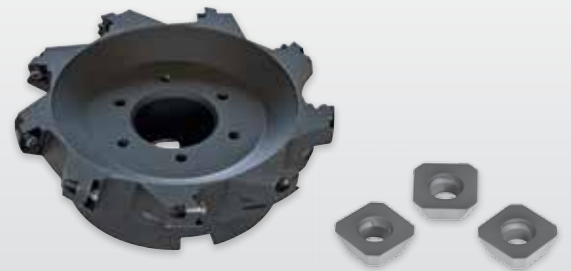

Applications

- ▶ Minimum workpiece thickness of 3 mm
- ▶ Suitable for steel, max. 1000 N/mm², aluminum, brass, copper, plastics, from soft plastic to acrylic glass, wood and much more
- ▶ Deburring of workpieces up to weld preparation

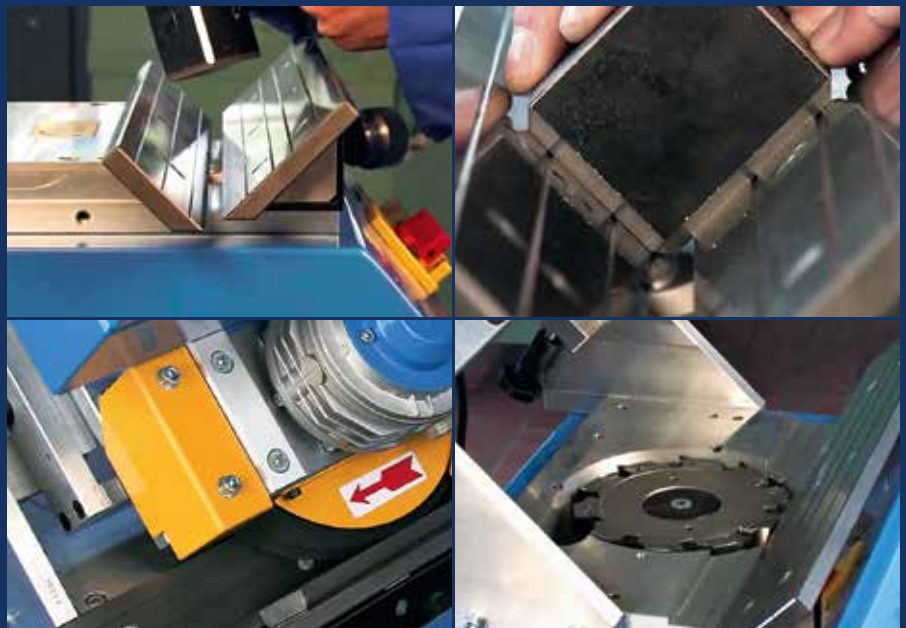



ASO 160-SSL

Professional advantages

- ▶ Small parts can be processed quickly and easily by hand
- ▶ Bars are chamfered by means of the automatic feed
- ▶ Constantly high surface quality

Features

- ✔ Chamfer adjustment by micrometer screw
- ✔ Speed regulation (ASO 160-SSL)
- ✔ Fast tool change
- ✔ V-prism for ideal guidance of the workpieces
- ✔ Hardened and polished guide bars
- ✔ Soft cutting pressure

Options

- ✔ Mobile undercarriage with big rubber rollers and integrated swarf drawer
- ✔ Automatic feed for series production and the processing of bars
- ✔ V-roller conveyor to extend the guide bars

Delivery contents

- ✔ Allen key of 5 mm and 6 mm
- ✔ Torx key T20
- ✔ Aluminum block for processing front sides
- ✔ Milling head equipped with inserts
- ✔ Swarf ejection tube (only with the ASO 160-SSL)
- ✔ Operating instruction

Specifications

	ASO 160-S	ASO 160-SSL
Motor	1.5 kW 2 800 rpm	1.5 kW 1 000 – 4 000 rpm
Energy	400 V, 50 Hz	400 V, 50 Hz
Max. chamfer width	10 mm	10 mm
Angular adjustment	45°	45°
Dimensions LxWxH	450 × 380 × 400 mm	450 × 380 × 400 mm
Weight	64 kg	64 kg
No.	22277	28569



Automatic module

ASO 160-M | ASO 160-MSL

Chamfering Machine with V-prism for Straight Edges

The chamfering without root face is the unique feature. Excellent chamfer quality is achieved by milling head with triangle inserts. The cut is soft and excellent in appearance.

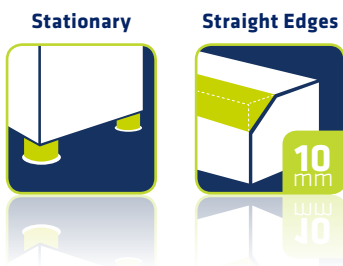

Further accessories can be found in our **Accessory Catalogue**.

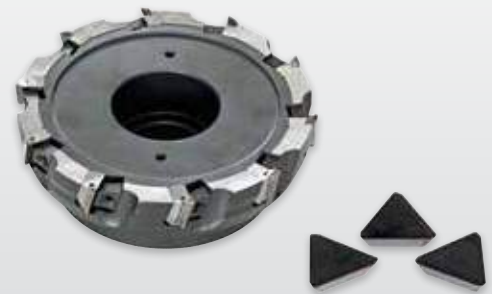

Application

- ▶ Minimum workpiece thickness of 1 mm
- ▶ Suitable for steel, max. 1000 N/mm², aluminum, brass, copper, plastics, from soft plastic to acrylic glass, wood and much more
- ▶ Deburring of workpieces up to weld preparation

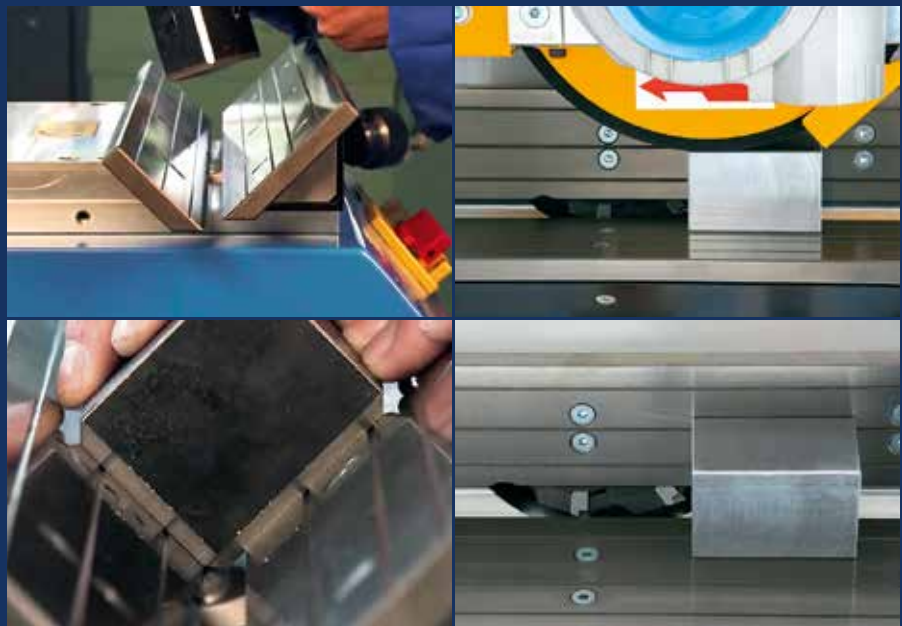



Professional advantages

- ▶ Sharp-edged chamfering is possible, e.g. a 3 mm x 45° bevel can be machined on a 3 mm thick workpiece
- ▶ Small parts can be processed quickly and easily by hand
- ▶ Bars are chamfered by means of the automatic feed
- ▶ Constantly high surface quality

ASO 160-MSL with a automatic module

Features

- ✔ Chamfer adjustment by micrometer screw
- ✔ Speed regulation (ASO 160-MSL)
- ✔ Fast tool change
- ✔ V-prism for ideal guidance of the workpieces
- ✔ Hardened and polished guide bars
- ✔ Soft cutting pressure

Options

- ✔ Mobile undercarriage with big rubber rollers and integrated swarf drawer
- ✔ Automatic feed for series production and the processing of bars
- ✔ Roller conveyor with V-prism to extend the guide bars

Delivery contents

- ✔ Allen key of 5 mm and 6 mm
- ✔ Torx key T20
- ✔ Aluminum block as support for manually feeding small workpieces
- ✔ Face cutter with inserts
- ✔ Swarf ejection tube (only with the ASO 160-MSL)
- ✔ Operating instructions

Specifications

	ASO 160-M	ASO 160-MSL
Motor	1.5 kW 2 800 rpm	1.5 kW 1 000 – 4 000 rpm
Energy	400 V, 50 Hz	400 V, 50 Hz
Max. chamfer width	10 mm	10 mm
Angular adjustment	45°	45°
Dimension (LxWxH)	450 × 380 × 400 mm	450 × 380 × 400 mm
Weight	64 kg	64 kg
No.	35035	35141



ASO 160-MSL with a under carriage

WKF 170

Chamfering Machine, angle adjustable

The perfect machine for chamfering small to mid-size work pieces and bar material. Thanks to its angle adjustment from 15° - 60°, it is mainly used for weld seam preparation.

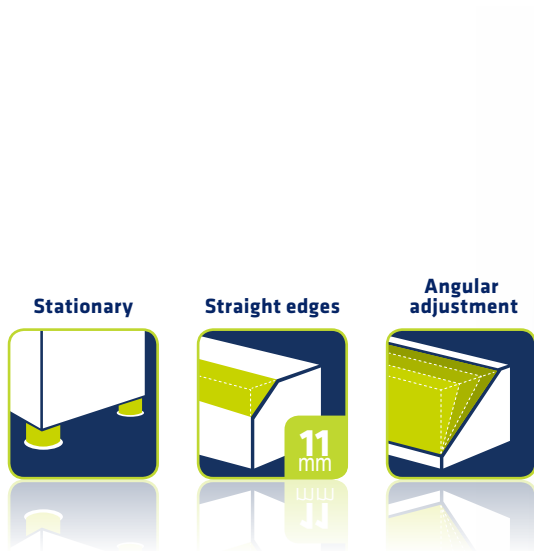

Application

- ▶ Minimum workpiece thickness 1 mm
- ▶ Can be used for steel, max. 1 000 N/mm², aluminum, brass, copper, plastics, from soft plastic to acrylic glass, wood and much more
- ▶ Deburring workpieces up to weld seam preparation

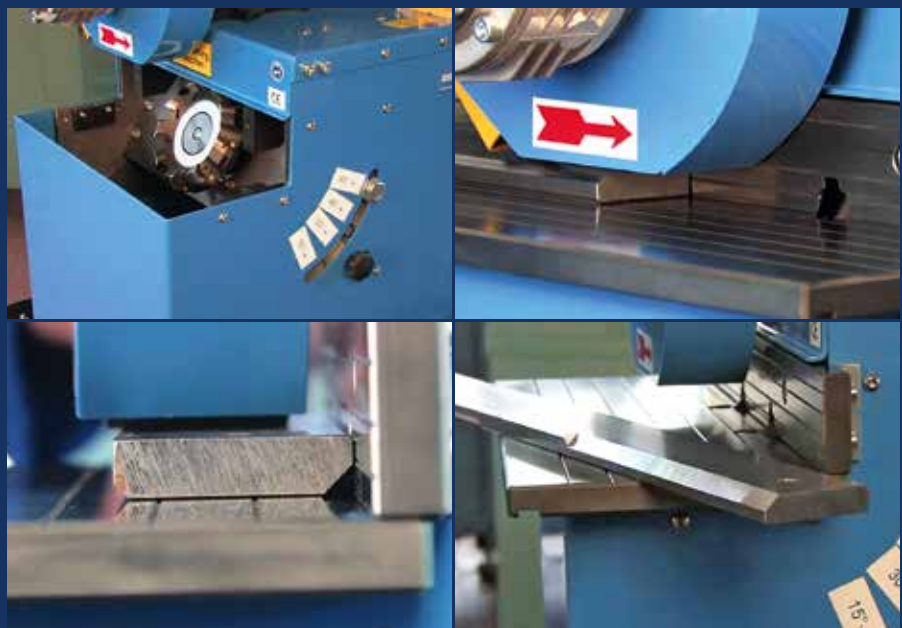



Further accessories can be found
in our **Accessory Catalogue**.

Professional advantages

- ▶ Simple and fast angular adjustment
- ▶ Consistent high surface quality
- ▶ Automatic feed facilitates chamfering
- ▶ Sharp-edges chamfering is possible, e. g. a 5 mm × 45° chamfer can be applied to a 5 mm thick workpiece

Features

- ✔ Angular adjustment from 15° – 60° (set-out every 5° possible)
- ✔ Chamfer adjustment by micrometer button
- ✔ Speed control for processing different materials
- ✔ Uncomplicated tool change
- ✔ Hardened and polished guide rails
- ✔ Soft cutting pressure

Options

- ✔ Mobile undercarriage with big rubber rollers and integrated swarf drawer
- ✔ Lateral stop for processing the front side
- ✔ Longitudinal stop for safe guidance of mass-produced parts
- ✔ Automatic feed for single-part and series production and processing bar materials
- ✔ Roller conveyors for extending the guide rails

Delivery contents

- ✔ Torx key T 25
- ✔ Plane cutter head with cutting inserts
- ✔ Lever support on the left side for setting the chamfer angle
- ✔ Operating instructions

Technical data

WKF 170

Motor	3.0 kW 1 000 – 4 000 rpm
Energy	400 V, 50/60 Hz
Max. chamfer width	11 mm
Angular adjustment	15° – 60°
Dimensions (LxWxH)	500 × 500 × 550 mm
Tabletop (LxW)	500 × 180 mm
Weight	100 kg
No.	54307



MMB 400 | MMB 500 | MMB 600

Chamfering Machine, angle adjustable

The machines show as well a high abrading power as a high chamfer quality. It is mainly used for welding bevels up to 25° - 60°, but also for optical bevels on straight edges, end of tubes and round steel plates.

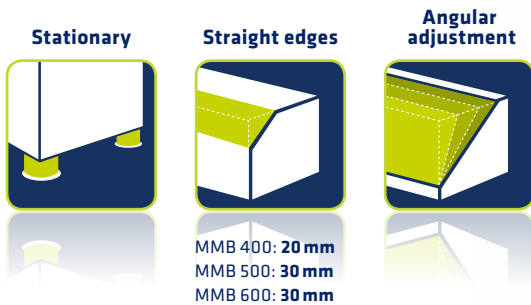

Application

- ▶ Minimum of workpiece thickness 3 mm
- ▶ Useable for steels, max. 1 000 N/m², aluminium, brass, copper, plastics, soft plastic and acrylic glass, wood and much more
- ▶ Deburring of workpieces up to the welding preparation
- ▶ Especially suitable for the series production





MMB 400

Professional advantages

- ▶ Precise workpiece guide
- ▶ Steady and consistent good surface quality
- ▶ Bar material can be chamfered by using the automatically feed
- ▶ Large pad table
- ▶ Chamfering without root face

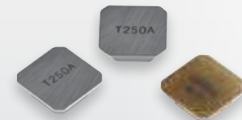

Further accessories can be found in our **Accessory Catalogue**.

Features

- ✔ Angle adjustment up to 25° - 60°
- ✔ Speed regulation for the processing of different materials
- ✔ Adjustable feed speed
- ✔ Minimum lubrication

Options

- ✔ Cutter head with round inserts
- ✔ Special construction for round steel plates
- ✔ Roller conveyors
- ✔ Motor with 7.5 kW
- ✔ Minimal lubrication device

Delivery contents

- ✔ Tory wrench
- ✔ Automatic feed
- ✔ Support lever for angle setting
- ✔ Cutter with inserts
- ✔ Operation instruction

Technical data

	MMB 400	MMB 500	MMB 600
Motor	5.5 kW 2 000 - 5 500 rpm	7.5 kW 2 000 - 5 500 rpm	7.5 kW 2 000 - 5 500 rpm
Energy	400 V, 50/60 Hz	400 V, 50/60 Hz	400 V, 50/60 Hz
Max. chamfer width	20 mm	30 mm	30 mm
Angular adjustment	30° - 60°	25° - 55° / 30° - 60°	25° - 55° / 30° - 60°
Max. workpiece thickness	100 mm	100 mm	180 mm
Dimensions (LxWxH)	920 x 1,350 x 1,800 mm	1,490 x 1,350 x 1,800 mm	1,600 x 1,500 x 1,650 mm
Pad table (LxW)	750 x 490 mm	1,490 x 700 mm	1,490 x 700 mm
Weight	500 kg	850 kg	800 kg
No.	69203	62871	63796

Speedy Kontur 270-K | Speedy Kontur 270-KSL | Speedy Kontur 320-K | Speedy Kontur 320-KSL

Beveling Machine for Contours

The stationary edge and contour beveling machines are perfectly suitable for deburring and chamfering internal and external edges of flat workpieces. The machines are compact and handy table devices which are ideally used also besides CNC machines.



Application

- ▶ For precise deburring and chamfering of internal and external edges of flat workpieces
- ▶ Can be used for steel, hardened steel, aluminum, brass, copper, plastics, from soft plastic to acrylic glass, wood and much more
- ▶ Suitable for continuous operation





Speedy Kontur 320-KSL

Further accessories can be found
in our **Accessory Catalogue**.

Professional advantages

- ▶ Perfect for alu and plastic processing
- ▶ Suitable for processing small to medium-sized workpieces
- ▶ Short tooling times at maximum flexibility
- ▶ Excellent chamfers by best spindle accuracy
- ▶ For continuous use with brushes motor

Features

- ✔ Easy operation
- ✔ Fast tool change
- ✔ Speed control (only with Speedy Kontur 270-KSL and Speedy Kontur 320-KSL)
- ✔ Chamfer angle can be changed due to contour cutter with different point angles

Options

- ✔ Guide finger, radius and chamfer cutter with guide ball bearing
- ✔ V-prism attachment for processing straight edges
- ✔ Slug remover-set for face milling
- ✔ Extraction socket
- ✔ Vacuum cleaner with automatic switch-on

Delivery contents

- ✔ Allen key 2.5 mm
- ✔ Guide ruler
- ✔ Full hard metal-form cutters $\varnothing 6$, pointed
- ✔ Operating instructions

Technical data

	Speedy Kontur 270-K	Speedy Kontur 270-KSL	Speedy Kontur 320 -K	Speedy Kontur 320 -KSL
Motor	0.18 kW 22 000 rpm	0.14 kW 12 000 – 28 000 rpm	0.14 kW 22 000 rpm	0.14 kW 12 000 – 28 000 rpm
Energy	230 V, 50 Hz	230 V, 50 Hz	230 V, 50 Hz	230 V, 50 Hz
Max. chamfer width	2 mm	2 mm	2 mm	2 mm
Guide ball bearing	min. $\varnothing 3$ mm	min. $\varnothing 3$ mm	min. $\varnothing 3$ mm	min. $\varnothing 3$ mm
Dimensions (LxWxH)	270 × 170 × 120 mm	270 × 170 × 130 mm	320 × 200 × 140 mm	320 × 200 × 140 mm
Weight	8 kg	9 kg	12 kg	13 kg
No.	1011	1053	961	938

KKE 1 | KKE 2

Beveling Machine for Contours

Straight edges, bores, long holes, grooves are chamfered precisely, fast and easily. V-prism attachment for the processing of straight edges rounds off the whole package. The big help for a small price.



Application

- ▶ Minimum workpiece thickness 1 mm
- ▶ Can be used for steel, hardened steel, aluminium, brass, copper, plastics, from soft plastic to acrylic glass, wood and much more
- ▶ Chamfering or rounding of external and internal contours





KKE 1

Further accessories can be found in our **Accessory Catalogue**.

Professional advantages

- ▶ Internal and external contours can be chamfered and rounded
- ▶ Dimensional accuracy thanks to ball bearing guide or guide ruler
- ▶ Very good chamfer quality
- ▶ Long tool life of the t.c cutters

Features

- ✔ Compact, handy tabletop unit next to the CNC milling machine and CNC lathe
- ✔ Precise chamfer adjustment
- ✔ Speed control for processing different materials
- ✔ Chamfer angle can be changed due to contour cutter with different point angles
- ✔ Fast tool change

Options

- ✔ V-prism attachment with extractor for straight edges
- ✔ Guide finger for stable guiding of workpieces with external contours

Delivery contents

- ✔ Guide ruler, box wrench 17 mm, union nut, allen key 3 mm, collet \varnothing 6 mm
- ✔ Open-ended wrench 14 mm
- ✔ Insert ring with borehole \varnothing 8 mm
- ✔ Prism with extraction socket, insert ring with borehole \varnothing 12 mm, collet \varnothing 8 mm, allen key 5 mm (only for KKE 2)
- ✔ Operating instructions

Technical data

	KKE 1	KKE 2
Motor	0.6 kW 8 000 – 24 000 rpm	0.6 kW 8 000 – 24 000 rpm
Energy	230 V, 50/60 Hz	230 V, 50/60 Hz
Max. chamfer width	3 mm	3 mm
Guide ball bearing	min. \varnothing 3 mm	min. \varnothing 3 mm
Dimensions (LxWxH)	300 x 250 x 320 mm	300 x 250 x 360 mm
Weight	20 kg	24 kg
No.	22129	29642



KKE 2

ASO 600-A | ASO 600-ASL

Beveling Machine for Contours

The small and compact machine chamfers or rounds edges precisely, safely and with ease. It leaves chatter-free bevels and radii on rectangular and round workpieces in different materials, internally and externally. Its universality makes the machine unique!



Application

- ▶ Minimum workpiece thickness 1 mm
- ▶ Can be used for steel, hardened steel, aluminium, brass, copper, plastics, from soft plastic to acrylic glass, wood and much more
- ▶ Chamfering or rounding of external and internal contours





ASO 600-A

Professional advantages

- ▶ For continuous use with brushless motor
- ▶ Tool change within a few seconds
- ▶ 0-point setting of cutters
- ▶ Inbuilt vacuum extractor

Further accessories can be found in our **Accessory Catalogue**.

Features

- ✔ Compact, handy tabletop unit next to the CNC milling machine and CNC lathe
- ✔ Precise chamfer adjustment
- ✔ Chamfer angle can be changed due to contour cutter with different point angles
- ✔ Fast tool change with tool setting device
- ✔ Hardened table with extraction socket

Options

- ✔ Prism attachment for straight edges
- ✔ Guide finger for the use of external contour
- ✔ Vacuum cleaner with automatic switch-on
- ✔ Special cutters on request

Delivery contents

- ✔ Guide ruler
- ✔ Inbuilt vacuum extractor for tube \varnothing 32 mm
- ✔ Open-ended wrench SW 17
- ✔ Insert ring with borehole \varnothing 12 mm
- ✔ Collet \varnothing 6 mm
- ✔ Union nut
- ✔ Operating instructions

Technical data

	ASO 600-A	ASO 600-ASL
Motor	0.25 kW 17 000 rpm	0.25 kW 9 000 - 21 000 rpm
Energy	230 V, 50/60 Hz	230 V, 50/60 Hz
Max. chamfer width	3 mm	3 mm
Guide ball bearing	min. \varnothing 3 mm	min. \varnothing 3 mm
Dimensions (LxWxH)	280 x 300 x 205 mm	280 x 300 x 205 mm
Weight	22 kg	23 kg
No.	10609	68674



ASO 600-A

KKF 4 | KKF 4-SL

Chamfering Machine for Contours

The spindle bearings mounted under pre-stress lend high-precision concentricity to the KKF 4. It can be used both full hard metal-form cutters and insert milling cutters, by means of which an excellent useful life is achieved.



Application

- ▶ Minimum workpiece thickness 1 mm
- ▶ Can be used for steel, hardened steel, aluminium, brass, copper, plastics, from soft plastic to acrylic glass, wood and much more
- ▶ Chamfering or rounding of external and internal contours

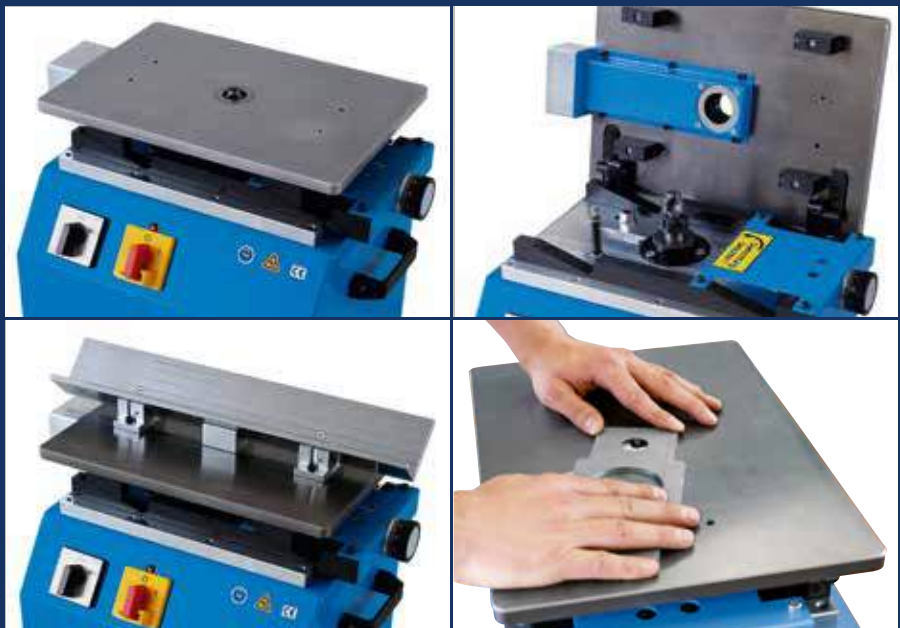



Further accessories can be found in our **Accessory Catalogue**.

KKF 4

Professional advantages

- ▶ Big supporting table with parallel table movement for height setting of chamfer
- ▶ Very good concentricity
- ▶ Continuous operation
- ▶ Tool change within a few seconds
- ▶ T.c. cutter with roller bearing dia 6 mm and shark cutter with roller bearing dia 16 mm

Features

- ✔ Precise chamfer adjustment by micrometer button
- ✔ Chamfer angle can be changed due to contour cutter with different point angles
- ✔ Fast tool change
- ✔ Wide selection of cutters
- ✔ Speed regulation
- ✔ Hardened machine table with extraction socket

Options

- ✔ Mobile undercarriage with big rubber rollers
- ✔ Prism attachment for straight edges
- ✔ Ruler
- ✔ Guide finger for the use of external contour
- ✔ Vacuum cleaner

Delivery contents

- ✔ Inbuilt vacuum extractor for tube \varnothing 32 mm or \varnothing 38 mm
- ✔ Insert ring with borehole \varnothing 30 mm
- ✔ Collet \varnothing 6 mm, 8 mm, 10 mm and 12 mm
- ✔ Union nut
- ✔ Operating instructions

Technical data

	KKF 4	KKF 4-SL
Motor	0.75 kW 13 000 - 26 000 rpm	0.75 kW 6 000 - 26 000 rpm
Energy	400 V, 50 Hz	400 V, 50 Hz
Max. chamfer width	4 mm	4 mm
Guide ball bearing	min. \varnothing 3 mm	min. \varnothing 3 mm
Dimensions (LxWxH)	490 x 340 x 430 mm	490 x 340 x 430 mm
Tabletop	400 x 280 mm	400 x 280 mm
Weight	55 kg	55 kg
No.	60063	63368



KKF 4

KKF 3

Chamfering Machine for Contours

It is our most powerful chamfering machine for edges and contours, having the biggest supporting table. Its sturdy insert milling cutters are ideally suitable for processing larger and heavier workpieces.



Application

- ▶ Minimum workpiece thickness 2 mm
- ▶ Can be used for steel, max. 1 000 N/mm², aluminum, brass, copper, plastics, from soft plastic to acrylic glass, wood and much more
- ▶ Chamfering or rounding of external and internal contours





Further accessories can be found
in our **Accessory Catalogue**.

Professional advantages

- ▶ Big supporting table
- ▶ Sturdy insert milling cutter with roller bearing \varnothing 16 mm or \varnothing 30 mm
- ▶ For continuous operation
- ▶ Inbuilt vacuum extractor

Features

- ✔ Precise chamfer adjustment by micrometer button
- ✔ Chamfer angle can be changed by using various insert milling cutters
- ✔ Fast and easy tool change
- ✔ Speed regulation
- ✔ Hardened machine table with extraction socket

Options

- ✔ Mobile undercarriage with big rubber rollers
- ✔ Vacuum cleaner
- ✔ Ruler
- ✔ Insert milling cutters with guide ball bearing \varnothing 16 mm or \varnothing 30 mm
- ✔ Radius inserts R1 - R5 mm
- ✔ Automatic feed

Delivery contents

- ✔ Inbuilt vacuum extractor for tube \varnothing 32 mm or \varnothing 38 mm
- ✔ Allen key 4 mm
- ✔ Torx key
- ✔ Operating instructions

Technical data

KKF 3

Motor	1.5 kW 1 000 - 7 500 rpm
Energy	400 V, 50 Hz
Chamfer width	5 mm
Guide ball bearing	min. \varnothing 16 mm
Cutter head	15° - 90°
Dimensions (LxWxH)	530 x 380 x 400 mm
Tabletop	520 x 330 mm
Weight	64 kg
No.	55111



TV 95-SL - Tub Vibrator

Stone Vibration Deburring and Slide Grinding Machine

As large as a washing machine, the tub vibrator has a capacity of 95 l.
It is our standard machine and ideal for prototypes and small series.



Paper filter PF440

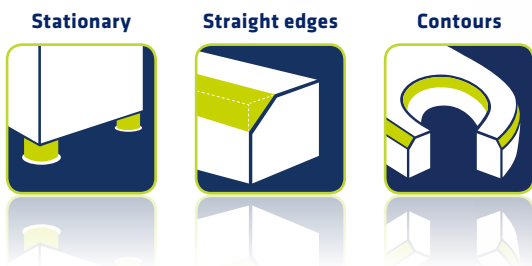

Further accessories can be found
in our **Accessory Catalogue**.

Application

- Deburring, polishing, brightening, cleaning and drying of laser-, water- or plasma steel cut small pieces or fine cut workpieces





TV 95-SL

Separator S95

Professional advantages

- ▶ Deburring and polishing different parts with just one machine
- ▶ Easy separation with the help of the separator
- ▶ Vibration strength freely selectable

Features

- ✔ Simple emptying via an outlet at the side of the machine
- ✔ Quiet due to noise protection hood
- ✔ With timer
- ✔ With integrated water tank for wet processing
- ✔ Sturdy, long-life construction with plastic-coated steel trough inside
- ✔ Mobile at any time by means of rollers on the underside
- ✔ Mixture ratio (grinding tool: workpieces) 7:1 to 3:1

Options

- ✔ Grinding and polishing media for individual application
- ✔ Additive (compounds)
- ✔ Separator
- ✔ Paper filter
- ✔ Collecting tub

Delivery contents

- ✔ Timer
- ✔ Water tank
- ✔ Pump
- ✔ Speed regulation
- ✔ Noise protection cover
- ✔ Operating instructions

Technical data

TV 95-SL 

Motor	1,1kW 1500 - 3 000 rpm
Energy	230 V, 50/60 Hz
Tub internal dimensions (LxWxH)	498 × 387 × 410 mm
Filling quantity	70 l
Dimensions (LxWxH)	730 × 650 × 910 mm
Weight	140 kg
No.	60546

TV 15-SL | 40-SL | 100-SL | 200-SL - Tub Vibrator

Stone Vibration Deburring and Slide Grinding Machine

The tub vibrators have a capacity from 18 to 240 l.

They make it possible to process workpieces with different shapes and sizes.

Sensitive workpieces can be contactless processed by means of chambers or workpiece carriers.



TV 200-SL



TV 40-SL

TV 15-SL

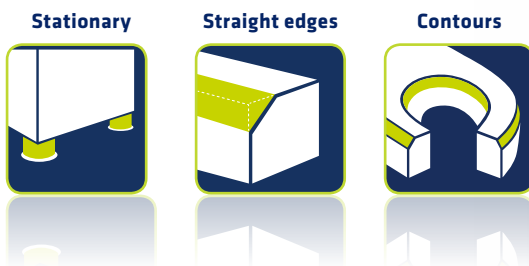

Accessories on request.



Features

- Sturdy, long-life construction with plastic-coated steel trough inside
- Consistent affect on the entire surface
- Very easy emptying of the tub after processing
- Ideal, also for longer workpieces

Options

- Grinding and polishing media for individual application
- Additive (compounds)
- Separator
- Noise protection cover, pneumatic
- Various possibilities for water treatment

Delivery contents

- Dosing pump
- Control with speed regulation
- Operating instructions

Technical data

	TV 15-SL	TV 40-SL	TV 100-SL	TV 200-SL
Motor	0.18 kW 1 200 - 1 500 rpm	0.55 kW 1 200 - 1 500 rpm	1.1 kW 1 200 - 1 500 rpm	1.5 kW 1 200 - 1 500 rpm
Energy	220 V, 50/60 Hz	220 V, 50/60 Hz	380 V, 50 Hz	380 V, 50 Hz
Tub internal dimensions (LxWxH)	500 x 200 x 200 mm	590 x 290 x 290 mm	1000 x 400 x 400 mm	1240 x 440 x 475 mm
Filling quantity	18 l	53 l	130 l	240 l
Dimensions (LxWxH)	630 x 300 x 500 mm	790 x 415 x 670 mm	1280 x 890 x 920 mm	1430 x 950 x 925 mm
Weight	50 kg	80 kg	300 kg	400 kg
Item no.	67144	67146	67147	67149

ASM 18 | ASM 60

Centrifugal Grinding Machine

The centrifugal grinding machine ASM is ideal for small parts and has a tenfold to twentyfold better processing intensity in comparison with conventional vibratory finishing machines. The centrifugal grinding machine can be planned as a single device up to a fully automatic plant.



ASM 18

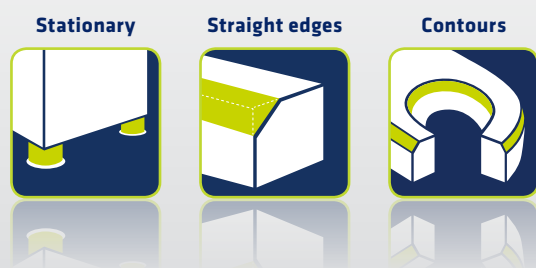

Accessories on request.

ASM 18

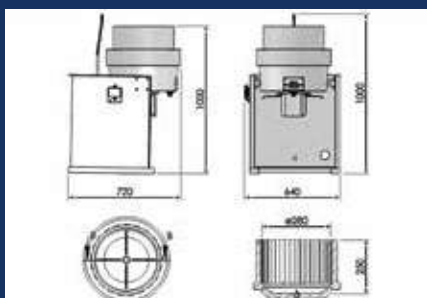

ASM 60

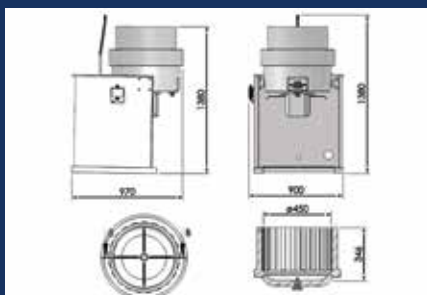

Features

- Sturdy, long-life construction with plastic-coated steel trough inside
- Easy emptying due to a tiltable work tank
- Compact device including base frame and manual separation (ASM 18)

Options

- Grinding and polishing media for individual application
- Additive (compounds)
- Separator
- Various opportunities for water treatment (e.g. paper filter)

Delivery contents

- Timer
- Dosing pump
- Manual sorting sieve (ASM 18)
- Controller
- Operating instructions

Technical data

	ASM 18	ASM 60
Motor	0.75 kW 1500 rpm	2.2 kW 1500 rpm
Energy	380 V, 50-60 Hz	380V, 50-60 Hz
Dimensions of work tank	Ø 280 x 250 mm	Ø 450 x 346 mm
Dimensions	720 x 640 x 1000 mm	970 x 900 x 1380 mm
Weight	120 kg	380 kg
Item no.	67883	67882

RV 40-SL | RV 120-SL | RV 220-SL | RV 420-SL - Rotary Vibrator

Stone Vibration Deburring and Slide Grinding Machine

The rotary vibrators can be universally used for deburring, rounding edges, cleaning up to polishing for small and short parts. As individual plant or in combination with further post-treatment equipment, such as dryer or separator, the rotary vibrator plant increases to a fully automatic deburring centre.

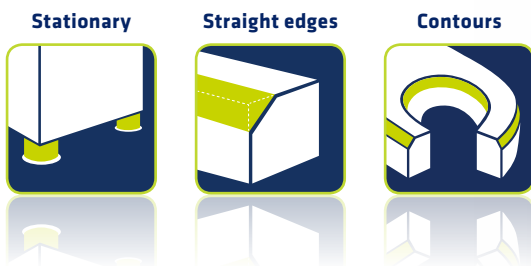

RV 220-SL

Accessories on request.

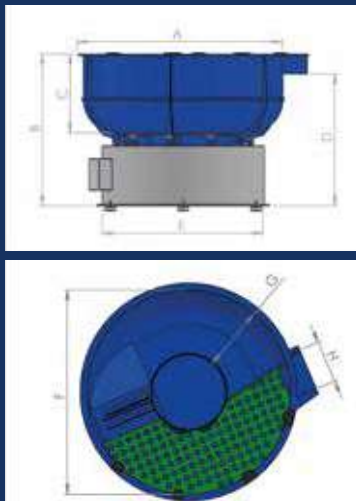

Features

- ✔ Simple emptying via an outlet at the side of the machine
- ✔ With timer
- ✔ Sturdy, long-life construction with plastic-coated steel trough
- ✔ Integrated separation
- ✔ Ease of operation and maintenance

Delivery contents

- ✔ Speed regulation
- ✔ Dosing pump
- ✔ Perforated screen
- ✔ Controller
- ✔ Operating instructions

Options

- ✔ Grinding and polishing media for individual application
- ✔ Additive (compounds)
- ✔ Pneumatic noise protection cover
- ✔ Separation flap, optionally manual or automatic
- ✔ Circular dryer
- ✔ Workpiece slide
- ✔ Various perforated screens for integrated separation
- ✔ Various opportunities for water treatment

Technical data

	RV 40-SL	RV 120-SL	RV 220-SL	RV 420-SL
Motor	0.37kW 1 200-1 500 rpm	1.1kW 1 200 - 1 500 rpm	1.1 kW 1 200-1 500 rpm	1.1 kW 1 200-1 500 rpm
Energy	380 V 50 Hz	380 V 50 Hz	380 V 50 Hz	380 V 50 Hz
Tube diameter (F= Ø)	525 mm	780 mm	1020 mm	1235 mm
Tube internal dimensions (F×G×C)	525 x 228 x 276 mm	780 x 284 x 315 mm	1020 x 300 x 430 mm	1235 x 380 x 480 mm
Filling quantity	26 l	80 l	146 l	280 l
Dimensions (A x B)	565 x 680 mm	852 x 791 mm	1150 x 1000 mm	1355 x 1000 mm
Weight	100 kg	225 kg	460 kg	780 kg
Item no.	68625	67782	67577	68013

RT 200 | RT 400 | RT 600 | RT 800 - Rotary Dryer

For the Rotary Vibrator

The rotary dryers are suitable for spotless drying of workpieces of all sorts. By using the hot-air blower, a uniform drying of the workpieces and of the granulates is ensured.

Stationary



Straight edges



Contours



RT 200

Accessories on request.

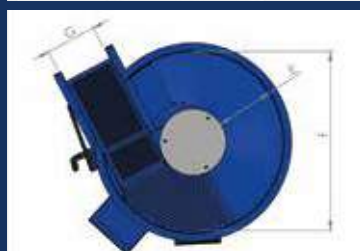

Features

- ✔ Sturdy, long-life construction with plastic-coated steel trough inside
- ✔ Consistent affect on the entire surface
- ✔ Spotless drying
- ✔ Consistent drying quality
- ✔ Increase tool life of granulate
- ✔ Good workpiece circulation and transport by tub vibrations

Options

- ✔ Dry media for individual application
- ✔ Separation flap, optionally manual or automatic

Delivery contents

- ✔ Controller
- ✔ Hot-air blower
- ✔ Separation flap, manual
- ✔ Operating instructions

Technical data

	RT 200	RT 400	RT 600	RT 800
Motor	1.1 kW 1 500 rpm	1.1 kW 1 500 rpm	1.1 kW 1 500 rpm	4.0 kW 1 500 rpm
Energy	380 V 50 Hz	380 V 50 Hz	380 V 50 Hz	380 V 50 Hz
Tub diameter (F= Ø)	1000 mm	1200 mm	1400 mm	1420 mm
Tub internal dimensions (F×E×B)	1000 x 315 x 440 mm	1200 x 380 x 500 mm	1400 x 460 x 550 mm	1420 x 530 x 630 mm
Dimensions (A x C)	1080 x 1010 mm	1280 x 1080 mm	1480 x 1180 mm	1500 x 1130 mm
Max. heating power	1000W	1000W	1600W	2400W
Temperature for the corn granules	50 °	50 °	50 °	50 °
Weight	350 kg	480 kg	570 kg	920 kg
Item no.	67689	68015	67879	67374

MZ 35 | MZ 90

Centrifuge

The centrifuge is a compact, space-saving and individual plant for the treatment of process water.

The dirt particles are separated with a 2 000-fold acceleration of gravity (g) from the process water.

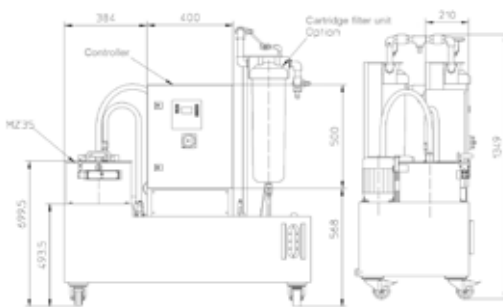

MZ 35

Accessories on request.

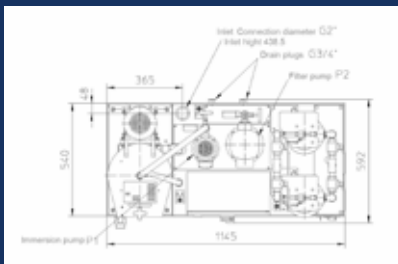

Features

- ✔ Easy operation
- ✔ Very high degree of cleaning
- ✔ Reuse of the liquids
- ✔ Kind to people and environment
- ✔ Can be used for several plants

Options

- ✔ Filter cartridges
- ✔ Solid cores

Delivery contents

- ✔ 2 solid cores
- ✔ Bypass for freshwater regulation
- ✔ Controller incl. control panel
- ✔ Operating instructions

Technical data

	MZ35 B20/80 ⚡	MZ90 B30/100 ⚡
Motor	0.75 kW 4 615 rpm	2.2 kW 3 723 rpm
Energy	230 V, 50 Hz	400 V, 50 Hz
Dimensions	1150 x 603 x 1404 mm	1318 x 894 x 1307 mm
Separation factor	2000 x g	1800 x g
Freshwater tank - volume	80 l	100 l
Wastewater tank - volume	20 l	30 l
Solid matter filling quantity	1.5 l	3.0 l
Rotor contents	3.0 l	4.5 l
Weight	120 kg	320 kg
Item no.	67886	68782

UA 5

Power Engine

Whether grinding, polishing, brushing or deburring - the universal drive engine UA 5 is used in all materials. A wide variety of tools makes the machine very flexible and indispensable in your production.

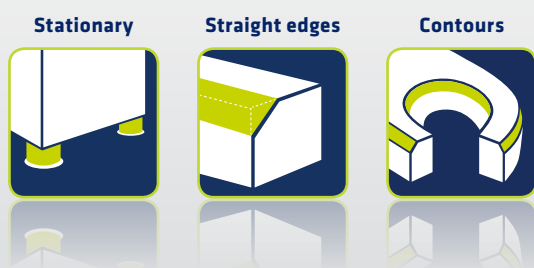

Further accessories can be found in our **Accessory Catalogue**.

Application

- ▶ **Mobile drive machine for the universal operation in the fabrication**
- ▶ **Grinding, polishing, brushing and deburring of all common materials with only one machine**
- ▶ **Flexible and mobile operation with flexible shaft**



Features

- ✔ Infinitely variable speed regulation
- ✔ Easy handling and operation
- ✔ Smooth running due to massive spindle bearing
- ✔ Maintenance-free due to frequency converter
- ✔ Usable for commercially available grinding, polishing, brushing and deburring tools

Options

- ✔ Extended shaft
- ✔ Flexible shaft
- ✔ Keyed chuck with mounting
- ✔ Grinding belt wheel
- ✔ Various grinding, polishing, brushing and deburring tools for individual use

Delivery contents

- ✔ 3× spindle mounts
- ✔ 3× star grinders each, big and small
- ✔ Cap
- ✔ Protective cover
- ✔ Operating instructions

Technical data

UA 5

Motor	0.75 kW 600 – 4 000 rpm
Energy	400 V, 50-60 Hz
Dimensions (LxWxH)	600 × 350 × 420 mm
Weight	45 kg
No.	29531

EDG 213 | EDG 1226

Drill Grinder

The handy drill grinders are ideal for grinding HSS- and HM-spiral drills. Due to the adjustable point angles from 90° to 140°, this model can be universally used. Easy handling and their efficiency make these machines a real winner in the field of drill grinding.



EDG 213

EDG 1226



EDG 213



Further accessories can be found in our **Accessory Catalogue**.

Application

- ▶ Grinding and top thinning of HSS- and HM-spiral drills

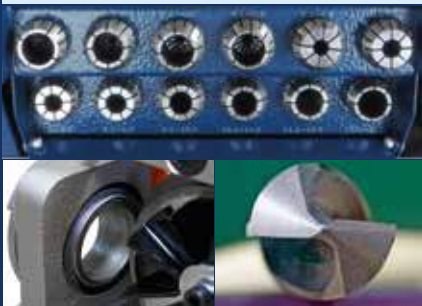

Features

- ✔ Good handling thanks to easy and practical design
- ✔ Top thinning and regrinding of drills by specially guided collet chucks
- ✔ With back taper for perfect cut
- ✔ Universe adjustable point angle
- ✔ Durable grinding disk

Options

- ✔ Diamond grinding disk

Delivery contents

- ✔ Allen key 4 mm
- ✔ Allen key 5 mm (for EDG 213)
- ✔ Allen key 6 mm (for EDG 1226)
- ✔ Spring pin (for EDG 1226)
- ✔ CBN grinding disk
- ✔ Collet set
- ✔ Tool holder
- ✔ Operating instructions

Technical data

	EDG 213	EDG 1226
Motor	0.15 kW 5 500 rpm	0.45 kW 4 500 rpm
Energy	230 V, 50/60 Hz	230 V, 50/60 Hz
Grinding area	ø 2 - 13 mm	ø 12 - 26 mm
Clearance angle/Point angle	90° - 140°	90° - 140°
Dimensions (LxWxH)	290 x 140 x 140 mm	450 x 230 x 190 mm
Weight	8.5 kg	26 kg
Art.-Nr.	42769	10212

Neutrix

Electrode Grinding Machine

The Neutrix is a small, low-weight portable grinding machine.
The electrode needle is centrally grinded and in longitudinal direction.
The precision of tungsten electrodes is quite accurate.
A stand can be mounted for use on the bench.

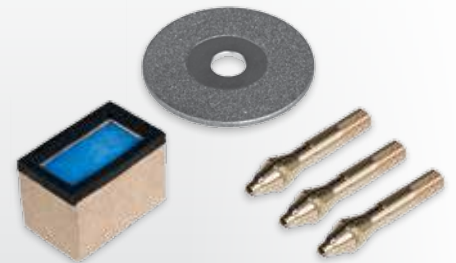

Further accessories can be found in our **Accessory Catalogue**.

Stationary



Application

- ▶ **Regrinding of tungsten electrodes for TIG, plasma, and orbital welding**



Features

- ✔ Integrated dust exhaust
- ✔ Stepless point angle 15° - 180°
- ✔ Eccentric disk enables 3-fold utilization of the diamond disk
- ✔ Short grinding time - only 0.3 mm consumption per grinding process due to grinding gauge
- ✔ Speed regulation for optimal grinding speed
- ✔ Grinding tungsten electrodes up to 15 mm is possible by means of a special collet

Technical data

Motor	0.12 kW 8 000 - 22 000 rpm
Energy	230 V, 50/60 Hz
LpA sound pressure level	88.8 dB/A
Vibration value	5 m/s ²
Diamond disk	ø 40 mm
Weight	3.0 kg
No.	10921

Options

- ✔ Stand
- ✔ Neutrix S with permanently attached stand and big dust filter

Delivery contents

- ✔ Allen key 2 and 4 mm
- ✔ Transport case
- ✔ Electrode holder with collet sections ø 1.6 / 2.4 / 3.2 mm
- ✔ Disposal bag for single-use filters
- ✔ Open-ended wrench SW 13/17 mm and 14/17 mm
- ✔ Diamond grinding disk
- ✔ Operating instructions

Neutrix ✔

WOULD YOU LIKE TO KNOW MORE?

**We will be happy to advise you.
By phone or during a personal meeting.**

➔ T +49 (0) 71 71 92 505-0 ➔ info@assfalg-metal.com



www.assfalg-metal.com

Assfalg GmbH

Buchstraße 149
73525 Schwäbisch Gmünd
Germany

Tel +49 (0) 71 71 92 505-0

Fax +49 (0) 71 71 92 505-50

assfalg