

GaAs DOUBLE-BALANCED MIXER

MM1-0320HSM

The MM1-0320HSM is a passive GaAs double balanced MMIC mixer suitable for both up and down-conversion applications. As with all Marki Microwave mixers, it features excellent conversion loss, isolation and spurious performance across a broad bandwidth and in a small form factor. The MM1-0320HSM is available in a lead-free, RoHS compliant QFN surface mount package and is compatible with standard leaded and lead-free PCB reflow soldering processes. The MM1-0320HSM is a superior alternative to Marki Microwave surface mount M1 and M3 mixers.

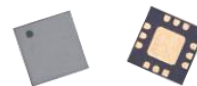

Features

- Compact 3mm QFN SMT Style Package
- Broadband Performance
- Excellent Unit-to-Unit Repeatability
- RoHS Compliant

Electrical Specifications - Specifications guaranteed from -55 to +100°C, measured in a 50Ω system. Specifications are shown for Configurations A & B. See page 2 for port locations.

Parameter	LO (GHz)	RF (GHz)	IF (GHz)	Min	Typ	Max	LO drive level (dBm)
Conversion Loss (dB) Configuration A Configuration B	3.5-20		DC-4		8 9	13 16	
Isolation (dB) LO-RF LO-IF RF-IF					See Plots		
Input 1 dB Compression (dBm)					+9 +9		Config. A: +13 to +20 Config. B: +12 to +17
Input Two-Tone Third Order Intercept Point (dBm)					+20 +20		Config. A: +13 to +20 Config. B: +12 to +17

Part Number Options

Model Number	Description
MM1-0320HSM-2 ¹	Surface Mount, IF Port Configuration -2
EVAL-MM1-0320H	Connectorized Evaluation Fixture

¹ Note: For port locations and I/O designations, refer to the drawings on page 2 of this document.

GaAs DOUBLE-BALANCED MIXER

Page 2

MM1-0320HSM

LO/RF 3.5 to 20 GHz
IF DC to 4 GHz

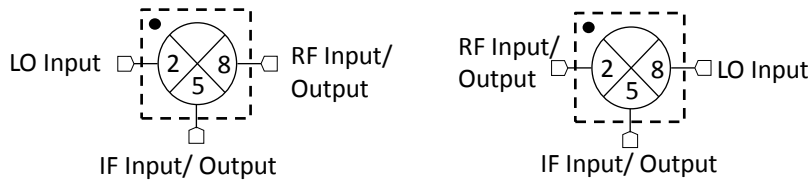

Configuration A

Configuration B

1. Configuration A/B refer to the same part number (MM1-0320HSM) used in one of two different ways for optimal spurious performance. For the lowest conversion loss, use the mixer in Configuration A (pin 2 as the LO input, pin 8 as the RF input or output). If you need to use a lower LO drive, use the mixer in Configuration B (pin 2 as the RF input or output, pin 8 as the LO input). For optimal spurious suppression, experimentation or simulation is required to choose between Configuration A and B. For more information, [see here](#).

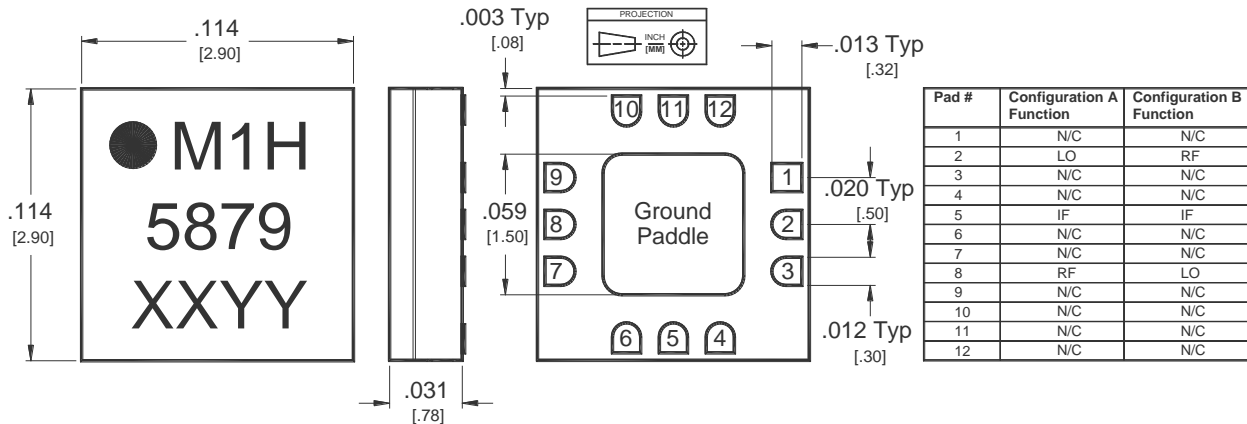

Outline Drawing – 3mm QFN package

Substrate material is Ceramic.

I/O Leads and Ground Paddle are 1.4±0.6 microns (55±24 micro-inches) Au over 1.3 microns (51 micro-inches) Ni.

All unconnected pads should be connected to PCB RF ground.

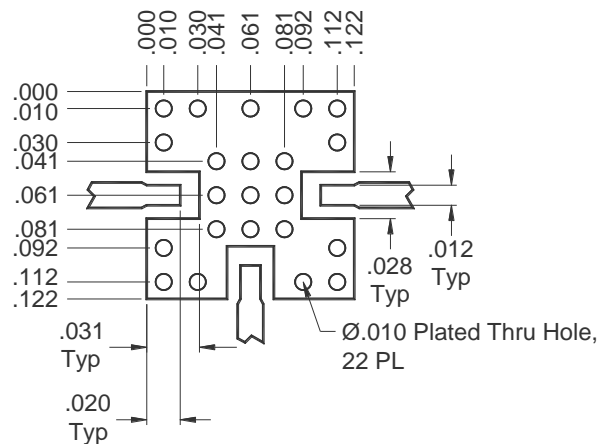

QFN-Package Surface-Mount Landing Pattern

[Click here for a DXF of the above layout.](#)

[Click here for leaded solder reflow.](#) [Click here for lead-free solder reflow.](#)

GaAs DOUBLE-BALANCED MIXER

Page 3

MM1-0320HSM

LO/RF 3.5 to 20 GHz
IF DC to 4 GHz

Typical Performance

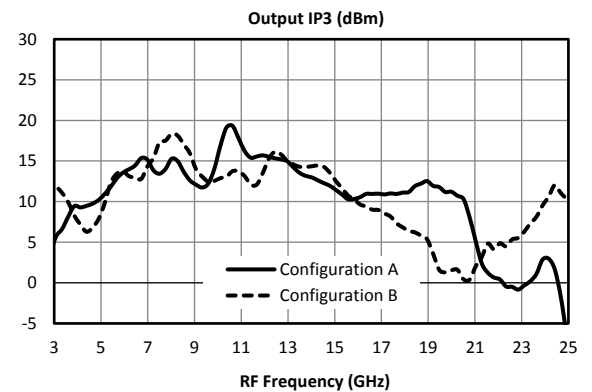
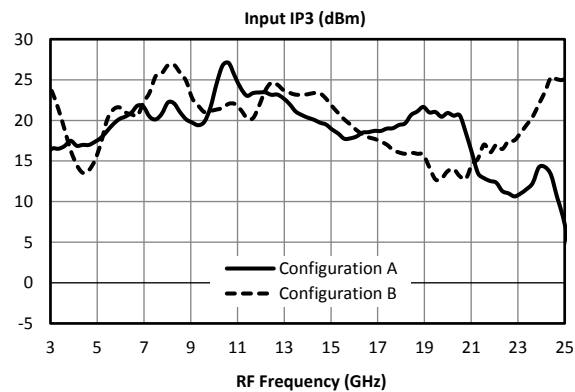
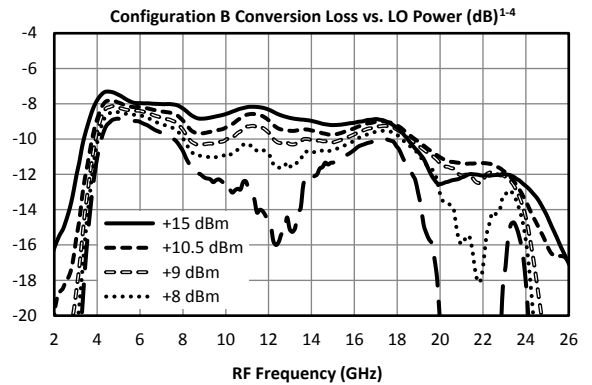
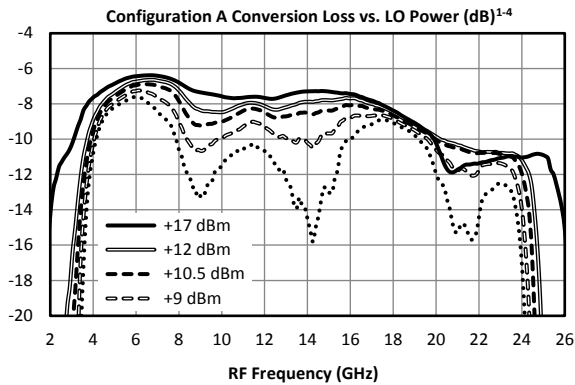
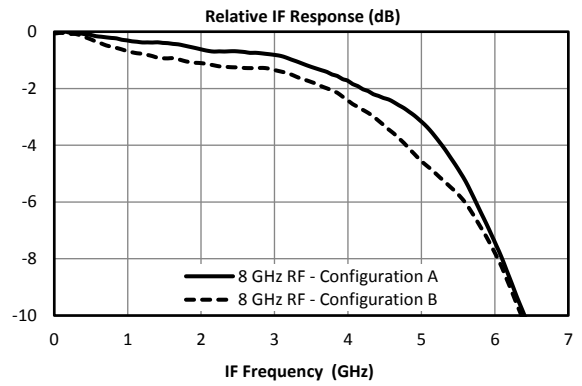
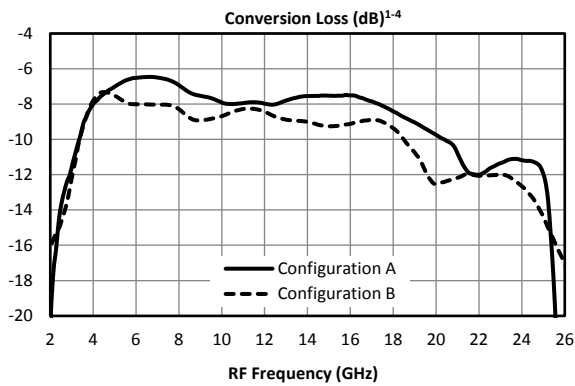

GaAs DOUBLE-BALANCED MIXER

Page 4

MM1-0320HSM

LO/RF 3.5 to 20 GHz
IF DC to 4 GHz

Typical Performance

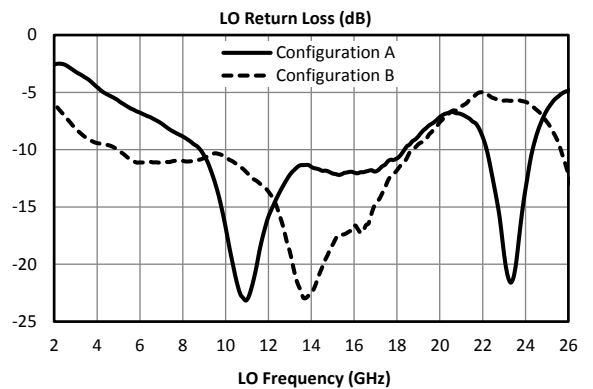
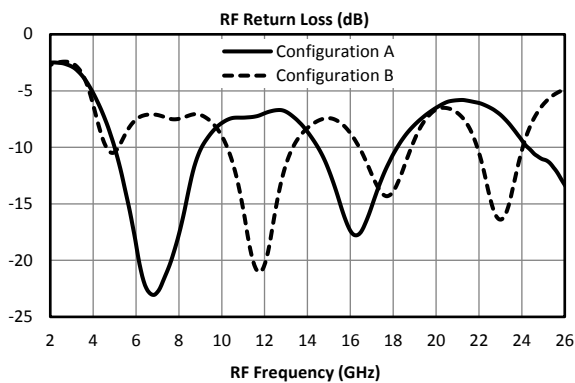
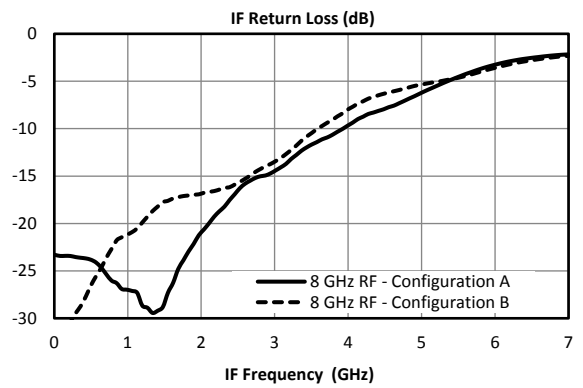
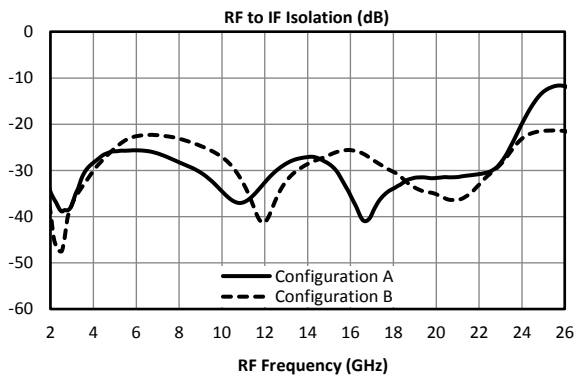
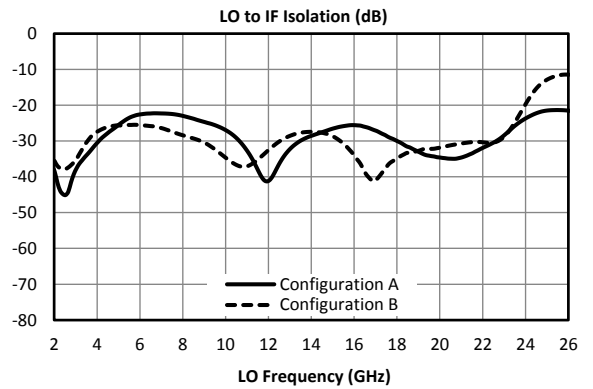
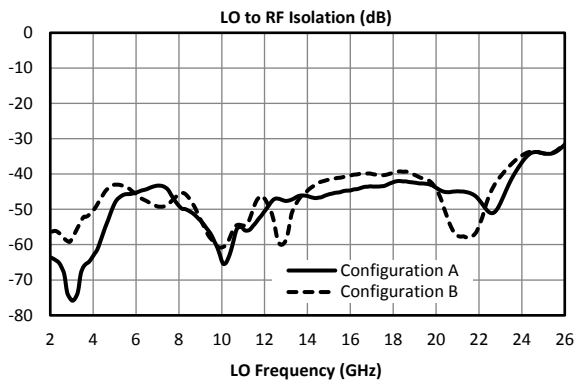

GaAs DOUBLE-BALANCED MIXER

Page 5

MM1-0320HSM

LO/RF 3.5 to 20 GHz
IF DC to 4 GHz

Typical Performance

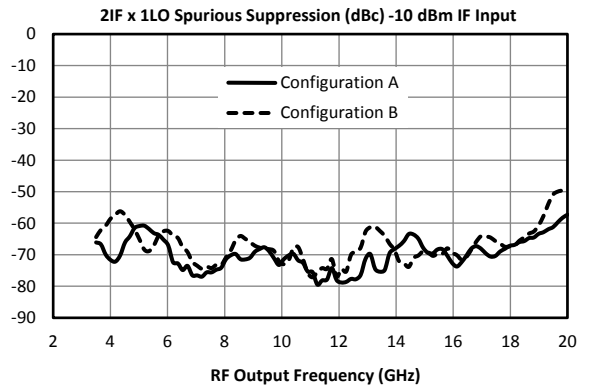
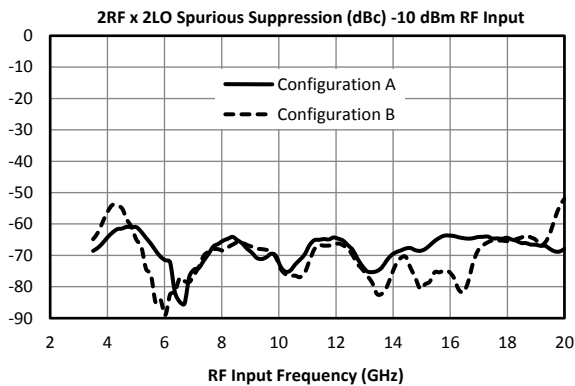
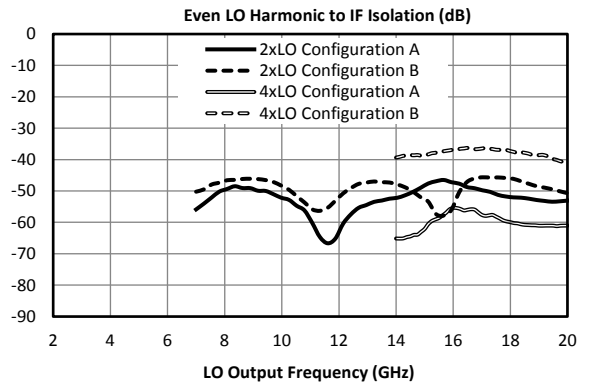
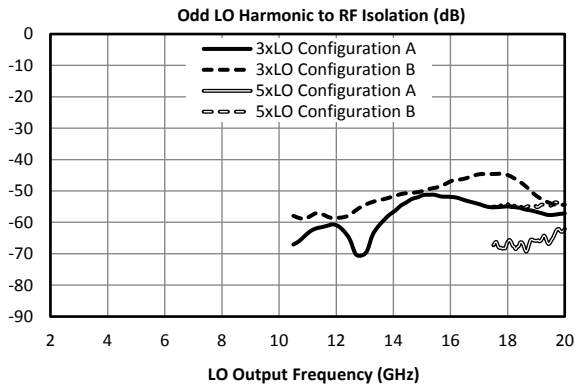
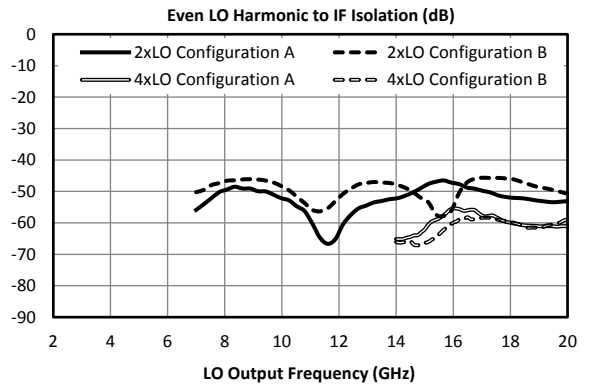
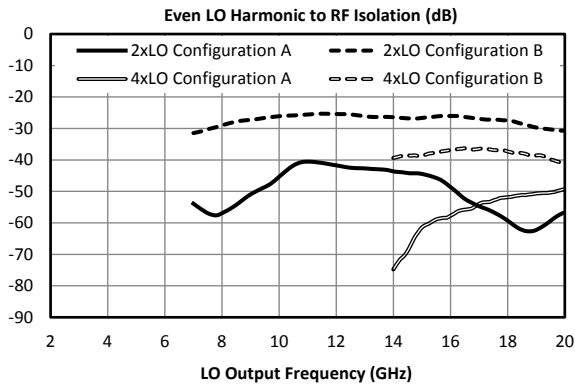



GaAs DOUBLE-BALANCED MIXER

MM1-0320HSM

Page 6

LO/RF 3.5 to 20 GHz
IF DC to 4 GHz

Downconversion Spurious Suppression

Spurious data is taken by selecting RF and LO frequencies ($\pm mLO \pm nRF$) within the RF/LO bands, to create a spurious output within the IF output band. The mixer is swept across the full spurious band and the mean is calculated. The numbers shown in the table below are for a -10 dBm RF input. Spurious suppression is scaled for different RF power levels by (n-1), where "n" is the RF spur order. For example, the 2RFx2LO spur is 68 dBc for the A configuration for a -10 dBm input, so a -20 dBm RF input creates a spur that is (2-1) x (-10 dB) dB lower, or 78 dBc.

Typical Downconversion Spurious Suppression (dBc): A Configuration (B Configuration) ⁴

-10 dBm RF Input	0xLO	1xLO	2xLO	3xLO	4xLO	5xLO
1xRF	22 (19)	Reference	19 (32)	13 (12)	36 (43)	20 (23)
2xRF	72 (73)	56 (52)	68 (70)	64 (50)	70 (64)	65 (51)
3xRF	86 (91)	67 (62)	78 (85)	72 (71)	80 (88)	68 (73)
4xRF	122 (122)	102 (106)	108 (110)	111 (106)	116 (114)	113 (104)
5xRF	135 (134)	122 (116)	120 (123)	120 (117)	126 (129)	122 (122)

Upconversion Spurious Suppression

Spurious data is taken by mixing an input within the IF band, with LO frequencies ($\pm mLO \pm nIF$), to create a spurious output within the RF output band. The mixer is swept across the full spurious output band and the mean is calculated. The numbers shown in the table below are for a -10 dBm IF input. Spurious suppression is scaled for different IF input power levels by (n-1), where "n" is the IF spur order. For example, the 2IFx1LO spur is typically 70 dBc for the A configuration for a -10 dBm input, so a -20 dBm IF input creates a spur that is (2-1) x (-10 dB) dB lower, or 80 dBc.

Typical Upconversion Spurious Suppression (dBc): A Configuration (B Configuration) ⁴

-10 dBm IF Input	0xLO	1xLO	2xLO	3xLO	4xLO	5xLO
1xIF	21 (25)	Reference	19 (32)	12 (11)	38 (43)	23 (22)
2xIF	55 (44)	70 (67)	60 (47)	72 (64)	63 (50)	64 (59)
3xIF	71 (80)	68 (71)	71 (85)	62 (67)	72 (79)	61 (56)
4xIF	111 (107)	114 (111)	110 (96)	112 (104)	101 (90)	105 (94)
5xIF	132 (135)	122 (122)	123 (126)	111 (109)	120 (120)	98 (96)

GaAs DOUBLE-BALANCED MIXER

Page 7

MM1-0320HSM

LO/RF 3.5 to 20 GHz
IF DC to 4 GHz

Application Circuit

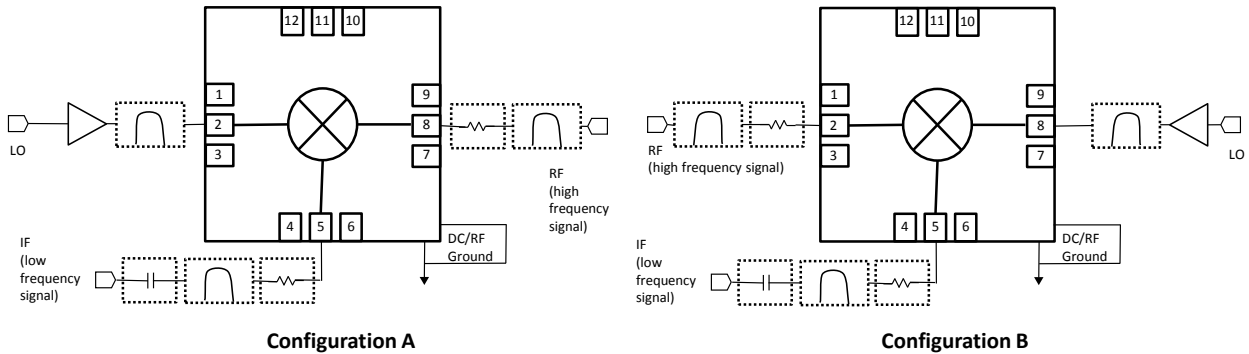

Operation

IF Port – Used as input on an upconversion, output on downconversion, or LO port in a band shifting application. Signals should be connected by 50 ohm microstrip or coplanar traces to well matched broadband 50 ohm sources and loads. Blocking capacitor is recommended if DC voltage is present on the line.

RF Port – Used as input on a downconversion, output on upconversion, or output in a band shifting application. Signals should be connected by 50 ohm microstrip or coplanar traces to well matched broadband 50 ohm sources and loads.

Filtering and Matching- Filtering is generally desired for spurious and image removal on the output port of the mixer. Reflective filters can cause out of band signals to reflect back into the mixer and cause conversion loss ripple, erroneous spurs, and other undesired behaviors. To eliminate these problems it is recommend that the filters be placed as close to the output port as possible. If undesired behavior is still observed, a diplexer with one port terminated or a 1-3 dB attenuator may reduce this problem.

RF Ground – The ground paddle of the QFN should be connected to a low noise RF ground with very low electrical resistance for high frequency operation.

LO Port – The noise floor of the LO input signal should be less than the value of the noise floor plus isolation of the mixer, or a filter is recommended to prevent reduction in dynamic range. An LO amplifier is required if the LO power is below the recommended drive level. It is important to use an amplifier with a broadband 50 ohm match such that it does not reflect spurious signals back into the mixer or other system circuitry.

Recommended LO Amplifier		
Package	Diode Option	Amplifier
SM	H	ADM-0126MSM



GaAs DOUBLE-BALANCED MIXER

Page 8

MM1-0320HSM

LO/RF 3.5 to 20 GHz
IF DC to 4 GHz

Port	Description	DC Interface Schematic
Port 2	Port 2 is DC short to ground and AC matched to 50 Ohms from 3.5 to 20 GHz. Blocking capacitor is optional.	
Port 5	Port 5 is DC coupled to the diodes. Blocking capacitor is optional.	
Port 8	Port 8 is DC short to ground and AC matched to 50 Ohms from 3.5 to 20 GHz. Blocking capacitor is optional.	

Absolute Maximum Ratings	
Parameter	Maximum Rating
Port 2 DC Current	15 mA
Port 5 DC Current	30 mA
Port 8 DC Current	15 mA
RF Power Handling (RF+LO)	+25 dBm at +25°C, derated linearly to +21 dBm at +100°C
Operating Temperature	-55°C to +100°C
Storage Temperature	-65°C to +125°C

DATA SHEET NOTES:

- Mixer Conversion Loss Plot IF frequency is 100 MHz.
- Mixer Noise Figure typically measures within 0.5 dB of conversion loss for IF frequencies greater than 5 MHz.
- Conversion Loss typically degrades less than 0.5 dB at +100°C and improves less than 0.5 dB at -55°C.
- Unless otherwise specified, data is taken with +15 dBm LO drive.
- Specifications are subject to change without notice. Contact Marki Microwave for the most recent specifications and data sheets.
- Catalog mixer circuits are continually improved. Configuration control requires custom mixer model numbers and specifications.