

Datasheet - AZM 170-11ZRK 24 VAC/DC

Solenoid interlock / AZM 170



Preferred typ



- Thermoplastic enclosure
- Double-insulated
- Compact design
- 90 mm x 84 mm x 30 mm
- 1 Cable entry M 20 x 1.5
- Interlock with protection against incorrect locking.
- Long life
- High holding force
- IDC method of termination
- Manual release

(Minor differences between the printed image and the original product may exist!)

Ordering details

Product type description	AZM 170-11ZRK 24 VAC/DC
Article number	101140788
EAN code	4030661119762
eCl@ss	27-27-26-03

Approval

Approval

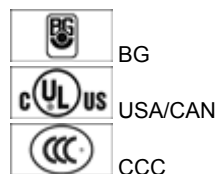

Classification

Standards	EN ISO 13849-1
B _{10d} Opener (NC)	2.000.000
Mission time	20 Years
notice	$MTTF_d = \frac{B_{10d}}{0,1 \times n_{op}}$ $n_{op} = \frac{d_{sp} \times h_{cp} \times 3600 \text{ s/h}}{t_{cycle}}$

Global Properties

Product name	AZM 170
Standards	EN 60947-5-1, BG-GS-ET-19
Compliance with the Directives (Y/N) 	Yes
Number of actuating directions	2 piece
Active principle	electromechanical
Duty cycle	Magnet 100 %
Materials	
- Material of the housings	Plastic, glass-fibre reinforced thermoplastic, self-extinguishing
- Material of the contacts	Silver
Housing coating	None
Weight	270 g

Mechanical data

Design of electrical connection	IDC method of termination
Cable section	
- Min. Cable section	1 x 0,75 mm ²
- Max. Cable section	1 x 1.0 mm ² , flexible
Mechanical life	> 1.000.000 operations
Emergency unlocking device (Y/N)	No
Manual release (Y/N)	Yes
- bottom	
Emergency release (Y/N)	No
Latching force	30 N
Positive break force	8.5 N
positive break travel	11 mm
Clamping force F	1000 N
Max. Actuating speed	2 m/s

Ambient conditions

Ambient temperature	
- Min. environmental temperature	-25 °C
- Max. environmental temperature	+60 °C
Protection class	IP67 to IEC/EN 60529

Electrical data

Design of control element	Normally open contact (NO), Opener (NC)
notice	change-over contact with double break, type Zb or 2 NC contacts, with galvanically separated contact bridges
Switching principle	Creep circuit element
Number of auxiliary contacts	1 piece
Number of safety contacts	1 piece
Power to unlock	Yes
Power to lock	No
Rated control voltage U _s	24 VAC/DC
Power consumption	max. 10 W
Rated impulse withstand voltage U _{imp}	4 kV
Rated insulation voltage U _i	250 V
Thermal test current I _{the}	10 A
Utilisation category	AC-15: 230 V / 4 A, DC-13: 24 V / 4 A

Max. fuse rating

6 A gG D-fuse

ATEX

Explosion protection categories for gases

None

Explosion protected category for dusts

None

Miscellaneous data

Applications



sliding safety guard,



removable guard,



hinged safety guard

Dimensions

Dimensions of the sensor

- Width of sensor 90 mm
- Height of sensor 84 mm
- Length of sensor 30 mm

notice

This type termination (IDC) method enables simple connection of flexible conductors without the need for the use of conductor ferrules
Individual coding available on request

Manual release

- For manual release using M5 triangular key, available as accessory

Diagram

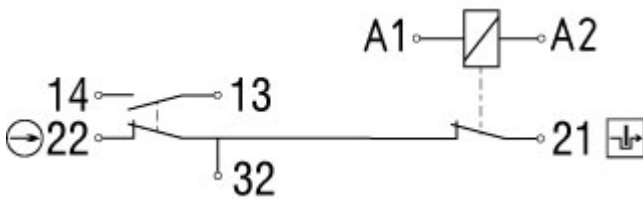

Note Diagram

- positive break NC contact
- active
- no active
- Normally-open contact
- Normally-closed contact

Switch travel diagram

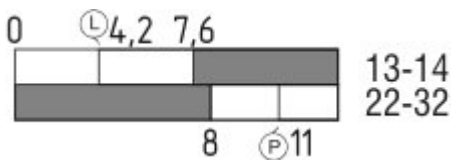

Notes Switch travel diagram

- Contact closed

- Contact open
- Setting range
- Break point
- Positive opening sequence/- angle
- VS** adjustable range of NO contact
- VÖ** adjustable range of NC contact
- N** after travel

Ordering suffix

The applicable ordering suffix is added at the end of the part number of the safety switch.

Order example: AZM 170-11ZRK 24 VAC/DC-**1637**

...- 1637	0,3 µm gold-plated contacts
... ST-2431	connector M12 , Individual solenoid monitoring

Ordering code

AZM 170(1)-(2)Z(3)K(4)-(5)-(6)-(7)

(1) <i>without</i> SK	IDC method of termination Screw connection
(2) 11 02 12/0.0	1 Normally open contact (NO) / 1 Opener (NC) 2 Opener (NC) 1 Normally open contact (NO), 2 Opener (NC) / -
(3) <i>without</i> R I	Latching force 5 N Latching force 30 N Individual coding
(4) <i>without</i> A	Power to unlock Power to lock
(5) <i>without</i> ST ST-2431	cable gland Connector M12 x 1 Connector M12 x 1, Individual solenoid monitoring
(6) 24VAC/DC 110VAC 230VAC	U _s 24 VAC/DC U _s 110 VAC U _s 230 VAC
(7) <i>without</i> 2197 1637	Manual release Manual release from side (Power to unlock) gold-plated contacts

AZM 170ST and AZM 170SK

AZM 170ST-(1)Z(2)K(3)-(4)-(5)-024

AZM 170SK-(1)Z(2)K(3)-(4)-(5)-024

(1)		
11/11		1 Normally open contact (NO), 1 Opener (NC) / 1 Normally open contact (NO), 1 Opener (NC)
11/02		1 Normally open contact (NO), 1 Opener (NC) / 2 Opener (NC)
12/00		1 Normally open contact (NO), 2 Opener (NC) / -
12/11		1 Normally open contact (NO), 2 Opener (NC) / 1 Normally open contact (NO), 1 Opener (NC)
12/02		1 Normally open contact (NO), 2 Opener (NC) / 2 Opener (NC)
02/01		2 Opener (NC), - / 1 Opener (NC), -
02/10		2 Opener (NC), - / 1 Normally open contact (NO), -
(2)		
<i>without</i>		Latching force 5 N
R		Latching force 30 N
(3)		
<i>without</i>		Power to unlock
A		Power to lock
(4)		
1637		gold-plated contacts
(5)		
2197		Manual release for Power to unlock

Documents

Operating instructions and Declaration of conformity (fr) 611 kB, 29.04.2016

Code: mrl_azm170_fr

Operating instructions and Declaration of conformity (de) 595 kB, 25.04.2016

Code: mrl_azm170_de

Operating instructions and Declaration of conformity (it) 609 kB, 08.07.2016

Code: mrl_azm170_it

Operating instructions and Declaration of conformity (cn) 655 kB, 08.05.2017

Code: mrl_azm170_cn

Operating instructions and Declaration of conformity (nl) 720 kB, 23.09.2010

Code: mrl_azm170_nl

Operating instructions and Declaration of conformity (en) 611 kB, 25.04.2016

Code: mrl_azm170_en

Operating instructions and Declaration of conformity (jp) 843 kB, 23.08.2016

Code: mrl_azm170_jp

Operating instructions and Declaration of conformity (pl) 651 kB, 08.07.2016

Code: mrl_azm170_pl

Operating instructions and Declaration of conformity (da) 582 kB, 07.08.2012

Code: mrl_azm170_da

Operating instructions and Declaration of conformity (es) 609 kB, 22.06.2016

Code: mrl_azm170_es

BG-test certificate (en) 260 kB, 09.12.2015

Code: z_m17p02

BG-test certificate (de) 257 kB, 09.12.2015

Code: z_m17p01

CCC certification (en) 1 MB, 13.06.2017

Code: q_371p02

CCC certification (cn) 1 MB, 13.06.2017

Code: q_371p03

EAC certification (ru) 809 kB, 05.10.2015

Code: q_6040p17_ru

Images

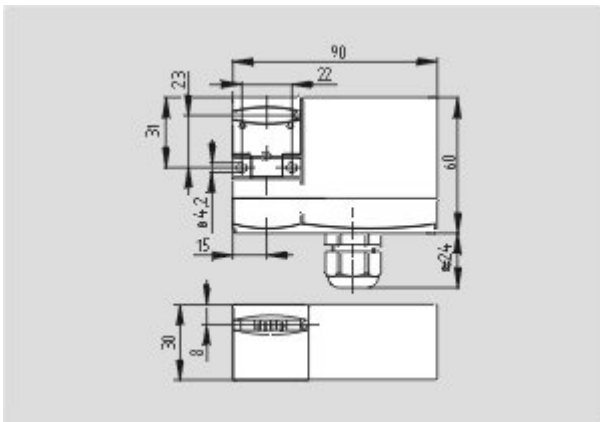

Dimensional drawing (basic component)

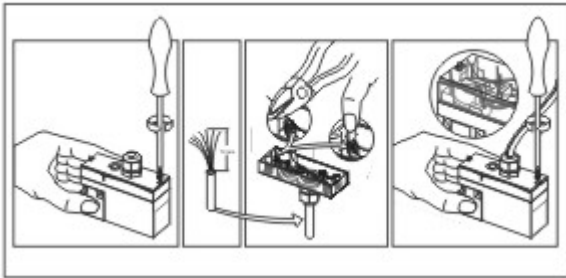

Assembly example

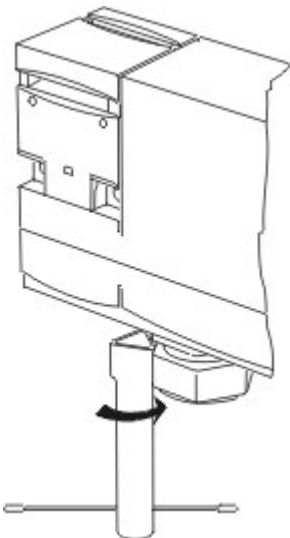

System components

Actuator



101122893 - AZ 17/170-B1

- Particularly suitable for sliding doors



101137406 - AZ 17/170-B1-2245

- Particularly suitable for sliding doors
- Damps vibration on guard device



101122895 - AZ 17/170-B5

- Particularly suitable for sliding doors



101139788 - AZ 17/170-B11

- Particularly suitable for sliding doors



101139789 - AZ 17/170-B15

- Particularly suitable for sliding doors



101123391 - AZM 170-B6

- Particularly suitable for hinged guards
- For very small actuating radii
- The direction of actuation can be selected by applicable insertion of the insert

Accessories

101208493 - AZM 170-B CENTERING GUIDE

- for AZ 17 and AZM 170



101100887 - TRIANGULAR KEY TK-M5

- For manual release using M5 triangular key, available as accessory
- For maintenance, installation, etc.

Connector



A-K4M12

- Pre-wired cable
- 4-pole



S-K4M12

- Connector without cable
- 4-pole

K.A. Schmersal GmbH & Co. KG, Möddinghofe 30, D-42279 Wuppertal

The data and values have been checked thoroughly. Technical modifications and errors excepted.

Generiert am 18.10.2017 - 13:34:01h Kasbase 3.2.7.F.64l